

RESMED

S7™ Elite

USER'S MANUAL

1

MANUEL UTILISATEUR

37

MANUAL DEL USUARIO

79

MANUAL DO UTILIZADOR

117

ENGLISH

FRANÇAIS

ESPAÑOL

PORTUGUÊS

Manufactured by:

ResMed Ltd 97 Waterloo Road North Ryde NSW 2113 Australia

Tel: +61 (2) 9886 5000 or 1 800 658 189 (toll free) Fax: +61 (2) 9878 0120 Email: reception@resmed.com.au

Distributed by:

ResMed Corp 14040 Danielson Street Poway CA 92064-8857 USA

Tel: +1 (858) 746-2400 or 1-800-424-0737 (toll free) Fax: +1 (858) 746-2900 Email: reception@resmed.com

ResMed (UK) Limited 65 Milton Park Abingdon Oxfordshire OX14 4RX UK

Tel: +44 (1235) 862 997 Fax: +44 (1235) 831 336 Email: reception@resmed.co.uk

ResMed Asia Pacific Ltd 97 Waterloo Road North Ryde NSW 2113 Australia

Tel: +61 (2) 9886 5000 or 1 800 991 900 (toll free) Fax: +61 (2) 9889 1471 Email: reception@resmed.com.au

ResMed Finland Niittykatu 6 FIN 02200 ESPOO Suomi

Puh: +358 9 8676820 Faksi: +358 9 86768222 Sähköposti: reception@resmed.fi

ResMed GmbH & Co. KG Rudolfstraße 10 D-41068 Mönchengladbach Deutschland

Tel: +49 (0) 2161-3521-0 (Reception), +49 (0) 180 22 22 668 (Service-Telefon; 0.06 €/Anruf),

+49 (0) 180 22 66 888 (Wartungstelefon; 0.06 €/Anruf) Fax: +49 (0) 2161-3521-1499 Email: reception@resmed.de

ResMed Hong Kong Limited Room 1714, Miramar Tower 132-134 Nathan Road Tsim Sha Tsui Hong Kong

Tel: +852 2366 0707 Fax: +852 2366 4546 Email: reception@resmed.com.hk

ResMed Japan Nihonbashi Hisamatsu Bldg. 4F, 2-28-1 Nihonbashi-Hamacho, Chuo-Ku, Tokyo 103-0007, Japan

Tel: +81 (3) 3662 5056 Fax: +81 (3) 3662 5040

ResMed Malaysia Sdn Bhd Suite E-10-20, Plaza Mon't Kiara No. 2 Jalan 1/70C Mon't Kiara 50480 Kuala Lumpur

Malaysia Tel: +60 3 6201 7177 Fax: +60 3 6201 2177 Email: reception@resmed.com.my

ResMed NZ Ltd PO Box 51-048 Pakuranga Auckland New Zealand

Tel: +64 274 737 633 Fax: +64 9 239 0193 Email: reception@resmed.co.nz

ResMed SA Parc de la Bandonnière 2, rue Maurice Audibert 69800 Saint-Priest France

Tél: +33 (0) 4 37 251 251 Fax: +33 (0) 4 37 251 260 Email: reception@resmed.fr

ResMed Singapore Pte Ltd 57 Ubi Ave 1 #07-09 Ubi Centre Singapore 408936

Tel: +65 6284 7177 Fax: +65 6284 7787 Email: reception@resmed.com.sg

ResMed Spain SL C/Arturo Soria, 245 28033 Madrid España

Tel: +34 (93) 5908154 Fax: +34 (93) 5908153 Email: angelo@resmed.es

ResMed Sweden AB Industrigatan 2 S-461 37 Trollhättan Sverige

Tel: +46 520 420 110 Fax: +46 520 397 15 Email: reception@resmed.se

Labhardt AG Thannerstrasse 57 CH-4054 Basel Schweiz

Tel: +41 (061) 307 9711 Fax: +41 (061) 307 9722 Email: info@labhardt.ch

US DESIGNATED AGENT: ResMed Corp

EU AUTHORIZED REPRESENTATIVE: ResMed (UK) Ltd

www.resmed.com

Protected by patents: AU 691200, AU 697652, AU 709279, AU 724589, AU 730844, AU 731800, AU 736723, AU 741687, AU 750095, AU 750761, EP 0651971(DE,FR,GB), EP 0661071(DE,FR,GB), NZ 504595, US 4944310, US 5199424, US 5245995, US 5522382, US 5704345, US 6029665, US 6138675, US 6152129, US 6240921, US 6279569, US 6363933, US 6367474, US 6398739, US 6425395, US 6502572, US 6591834, US 6635021. Other patents pending.

Protected by design registrations: AU 147283, AU 147335, AU 147336, CH 128.709, CH 128.710, CH 128.711, DE 40202007, DE 40202008, DE 40201723, DE 40202020, ES 153514, ES 153515, ES 153516, ES 153518, FR 02 1407, GB 3001791, GB 3001819, GB 3001820, GB 3001821, JP 1164087, JP 1164265, JP 1164266, JP 1164267, SE 75598, SE 75599, SE 75600, SE 75715, US D467335, US D468011, US D476077, US D477868. Other designs pending.

S7, SmartStart, HumidAire, HumidAire 2i, Mirage, Ultra Mirage, Vista, Activa, AutoSet,  ,  , and Smart Data are trademarks of ResMed Ltd.

RESMED

ENGLISH

ResMed S7™ Elite

USER'S MANUAL

English (USA)

CONTENTS

INTRODUCTION	3
DEFINITIONS	3
USER/OWNER RESPONSIBILITY	3
MEDICAL INFORMATION	3
WHAT A RESMED S7™ ELITE UNIT IS FOR	3
TELL YOUR DOCTOR IF...	3
WARNINGS	4
CAUTIONS	5
THE RESMED S7 ELITE SYSTEM	7
RESMED S7 ELITE COMPONENTS	7
MASKS	8
HUMIDIFIER	8
ACCESSORIES	9
PREPARING FOR USE	11
SETTING UP THE RESMED S7 ELITE	11
FEATURES OF THE RESMED S7 ELITE	17
OPERATING INSTRUCTIONS	23
STARTING TREATMENT	23
STOPPING TREATMENT	24
USING THE MASK-FITTING FEATURE	24
HELPFUL HINTS	25
CLEANING AND MAINTENANCE	27
DAILY	27
WEEKLY	27
PERIODICALLY	27
REPLACING THE AIR FILTER	28
SERVICING	28
TROUBLESHOOTING	29
SYSTEM SPECIFICATIONS	31
LIMITED WARRANTY	33

INTRODUCTION

DEFINITIONS

This manual contains special terms and icons that appear in the margins to draw your attention to specific and important information.



WARNING

Alerts you to possible injury.



CAUTION

Explains special measures for the safe and effective use of the device.

Note: *Is an informative or helpful note.*

USER/OWNER RESPONSIBILITY

The user or owner of this system shall have sole responsibility and liability for any injury to persons or damage to property resulting from:

- operation which is not in accordance with the operating instructions supplied
- maintenance or modifications carried out unless in accordance with authorized instructions and by authorized persons.

Please read this manual carefully before use.

MEDICAL INFORMATION

WHAT A RESMED S7™ ELITE UNIT IS FOR

The RESMED S7™ ELITE system is intended for the treatment of adult patients with obstructive sleep apnea (OSA). The optional integrated humidifier (HUMIDAIRE 2i™ or HUMIDAIRE 2iC™) is indicated for the humidification and warming of air from the RESMED S7 ELITE flow generator. The RESMED S7 ELITE CPAP flow generator, HUMIDAIRE 2i, and HUMIDAIRE 2iC are for home and hospital use.



CAUTION (USA ONLY)

Federal law restricts this device to sale by or on the order of a physician.

TELL YOUR DOCTOR IF...

You must tell your doctor, and CPAP (continuous positive airway pressure) therapy must not be used, if you have any of the following conditions:

- pneumothorax or pneumomediastinum (air in the pleural cavity or mediastinum)
- severe heart failure, low blood pressure, or dehydration

- surgery to the brain, middle or inner ear, pituitary gland, or sinuses
- respiratory distress syndrome
- middle ear infection or perforated ear drum
- severe nosebleed.

WARNINGS

CPAP therapy should be used with caution if you have any of the following conditions:

- respiratory failure
- cavities or cysts in the lung (called bullae, and usually due to emphysema), or previous history of pneumothorax
- previous history of severe nosebleed
- sinus infection.

Tell your doctor if you have any of these conditions. Your doctor will advise you whether the likely benefits of CPAP therapy outweigh the expected risks.

Special care should be exercised if you are dehydrated, or may become dehydrated, for example as a result of fluid restriction or diuretic therapy (including changes in therapy).

Discontinue therapy and seek medical advice if, during therapy or when you start therapy each night, you feel faint or light-headed.

The following are general warnings that pertain to your use of a RESMED S7 ELITE unit. Specific warnings appear next to the relevant instructions in the manual.



WARNING

- **This is NOT a life support device.** It may stop operating with power failure or if a fault occurs in the unit.
- The air flow for breathing produced by this device can be as much as 11°F (6°C) higher than the temperature of the room. Caution should be exercised if the room temperature is warmer than 90°F (32°C).
- The RESMED S7 ELITE unit should only be used with masks (and connectors)* recommended by ResMed, or by your physician or respiratory therapist. A mask should not be used unless the RESMED S7 ELITE unit is turned on and operating properly. The vent hole or holes associated with the mask should never be blocked.

Explanation: The RESMED S7 ELITE unit is intended to be used with special masks (or connectors)* which have vent holes to allow continuous flow of air out of the mask. When the device is turned on and functioning properly, new air from the device flushes the exhaled air out through the mask vent holes. However, when the device is not operating, insufficient fresh air will be provided through the mask, and the exhaled air may be rebreathed. Rebreathing of exhaled air for longer than several minutes can, in some circumstances, lead to suffocation. This applies to most models of CPAP devices.

* Ports may be incorporated in the mask or in connectors that are near the mask.

- The RESMED S7 ELITE unit should only be connected to the components, humidifiers, or accessories specified in this manual. Connection of other items may result in injury, or damage to the RESMED S7 ELITE unit.
- At low pressures, the flow through the exhalation ports of your mask may not clear all exhaled gas from the tubing. Some rebreathing may occur.
- Explosion hazard—do not use in the vicinity of flammable anesthetics.

WARNINGS RELATED TO TREATMENT



WARNING

- If you stop your CPAP treatment, your sleep apnea will return.
- Always consult your clinician if you expect to be in a situation where you cannot use your RESMED S7 ELITE unit.
- If you are admitted to a hospital or prescribed any other form of medical treatment, always inform the medical staff that you are being treated with CPAP. It is also important to contact the clinician who is treating you for sleep apnea.
- If you experience an infection of the upper respiratory tract, middle ear, or sinuses, contact your clinician before continuing your CPAP treatment. You may be advised to stop treatment until the infection has cleared. If you continue with treatment during an infection, be sure to clean your mask and tubing after every use.

WARNINGS RELATED TO OXYGEN USE



WARNING

If oxygen is used with this device, the oxygen flow must be turned off when the device is not operating.

Explanation: when the CPAP device is not in operation and the oxygen flow is left on, oxygen delivered into the air delivery tubing may accumulate within the CPAP machine enclosure and create a risk of fire. This applies to most types of CPAP machines.

- Oxygen supports combustion. Oxygen should not be used while you are smoking or in the presence of an open flame.
- Always ensure airflow is being generated by the device before the oxygen supply is turned on.
- Always turn the oxygen supply off before stopping the airflow from the device.

Note: At a fixed rate of supplemental oxygen flow, the inhaled oxygen concentration will vary, depending on where the oxygen is introduced, the pressure settings, patient breathing pattern, mask selection, and leak rate.

CAUTIONS

The following are general cautions. Specific cautions appear next to the relevant instructions in the manual.



CAUTION

Do not open the RESMED S7 ELITE case. There are no user serviceable parts inside. Repairs and internal servicing should only be performed by an authorized service agent.

POSSIBLE SIDE EFFECTS

The RESMED S7 ELITE flow generator is designed to help you have a good night's sleep. However, you need to be aware of possible problems that may arise during CPAP treatment.



WARNING

Consult your clinician immediately if you experience any of the following symptoms during your CPAP treatment:

- headache
- middle ear or sinus discomfort
- chest pain
- dryness of the nose, mouth, or throat
- feeling bloated due to air swallowing
- air continually leaking out of the mouth while sleeping
- recurrence of any sleep apnea symptoms while on CPAP.

Skin irritation may occur from sensitivity to the mask materials or from excessively tight headgear straps. A correctly fitted mask and appropriately adjusted straps will often prevent skin irritation. If problems persist, contact your clinician for advice.

THE RESMED S7 ELITE SYSTEM

RESMED S7 ELITE COMPONENTS

Please identify and familiarize yourself with the following components of the RESMED S7 ELITE UNIT:

RESMED S7 ELITE Unit

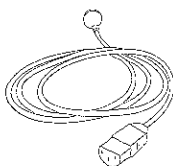
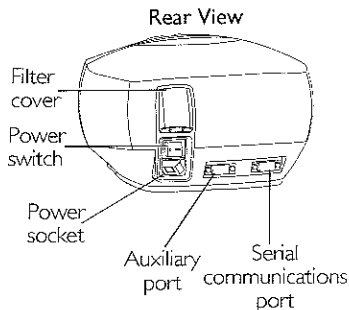
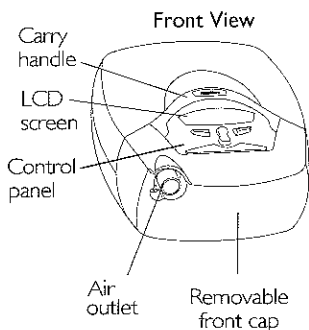

Power cord



Pressure sensor adapter



Carry bag

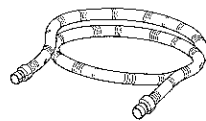

Air tubing 6ft 6in (2m)



WARNING

- Do not connect any device to the auxiliary port. Although your health care provider may connect specially designed devices to the auxiliary port of the RESMED S7 ELITE unit, connection of other devices could result in injury, or damage of the unit.
- In the clinical environment any personal computer that is used with your CPAP system must be at least 5ft (1.5m) away from, or at least 8ft (2.5m) above, the patient. It must also comply with the relevant test standard. For personal computers the international standard is IEC 60950 or equivalent.

MASKS

You will also need a **ResMed mask system** (supplied separately).

The following ResMed mask systems are recommended for use with the RESMED S7 ELITE:

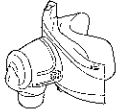

MIRAGE VISTA™
NASAL MASK



ULTRA MIRAGE™
NASAL MASK

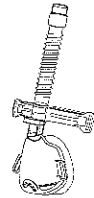

MIRAGE™
NASAL MASK

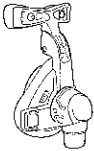

MIRAGE ACTIVA™
NASAL MASK



MODULAR NASAL
MASK



MIRAGE™
FULL FACE MASK

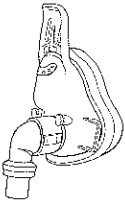

MIRAGE™
FULL FACE MASK
SERIES 2

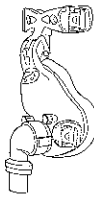

ULTRA MIRAGE™
FULL FACE MASK

HUMIDIFIER

A humidifier may be required if you are experiencing dryness of the nose, throat, or mouth. The RESMED S7 ELITE is compatible for use with the following humidifiers.

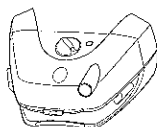

HUMIDAIRE 2i™ heated humidifier

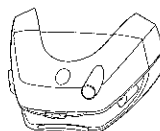

HUMIDAIRE 2iC™ humidifier



HUMIDAIRE™ heated humidifier

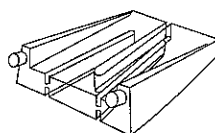

RESMED PASSOVER humidifier



WARNING

Only the HUMIDAIRE 2i, HUMIDAIRE 2iC, HUMIDAIRE heated humidifier, and the RESMED PASSOVER are compatible for use with the RESMED S7 ELITE. Please refer to “Warnings” on page 4.

ACCESSORIES

The following accessories are available for use with the RESMED S7 ELITE:

RESMED S7 ELITE ACCESSORIES

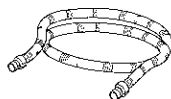

Air tubing
9ft10in (3m)

HUMIDIFIER ACCESSORIES

(HUMIDAIRE and RESMED PASSOVER only)

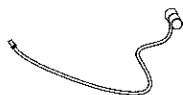

Pressure sensor line
(HUMIDAIRE and PASSOVER)



Short air tubing
7.5in (19cm)
(HUMIDAIRE only)

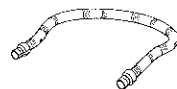

Medium air tubing
21in (52cm)
(HUMIDAIRE and PASSOVER)

PREPARING FOR USE

SETTING UP THE RESMED S7 ELITE

- 1 Place the RESMED S7 ELITE unit on a table near the head of your bed.



CAUTION

Be careful not to place the device where it can be bumped or where someone is likely to trip over the power cord.

Note: The ResMed S7 Elite unit may be placed on the floor beside or underneath your bed. Ensure that the area is free from dust and clear of bedding, clothes, or any other objects that could block the air inlet.

- 2 Connect the power cord to the socket at the rear of the flow generator. Plug the other end of the power cord into a power outlet.



WARNING

Make sure the power cord and plug are in good condition and the equipment is not damaged.

The air filter cover protects the device in the event of accidental liquid spillage onto the device. Ensure that the air filter and air filter cover are fitted at all times.

- 3 Align the pressure sensor adapter with the pressure port. Fit the pressure sensor adapter onto the air outlet of the unit.

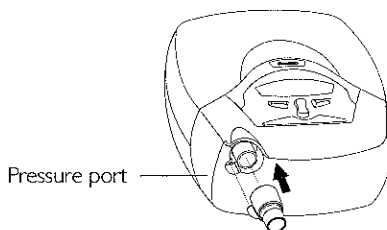

- 4 Connect one end of the air tubing firmly onto the pressure sensor adapter.

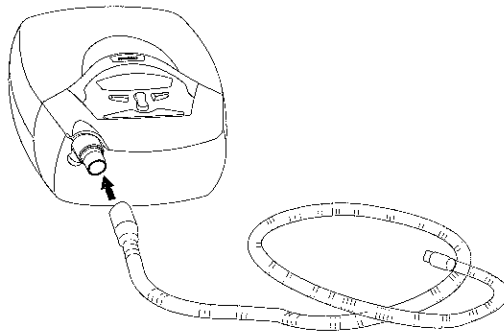

WARNING

Only ResMed air tubing should be used with your flow generator. A different type of air tubing may alter the pressure you actually receive reducing the effectiveness of your treatment.

-
- 5 Assemble your mask system according to the mask user instructions.
 - 6 Connect your mask system to the free end of the air tubing.
-

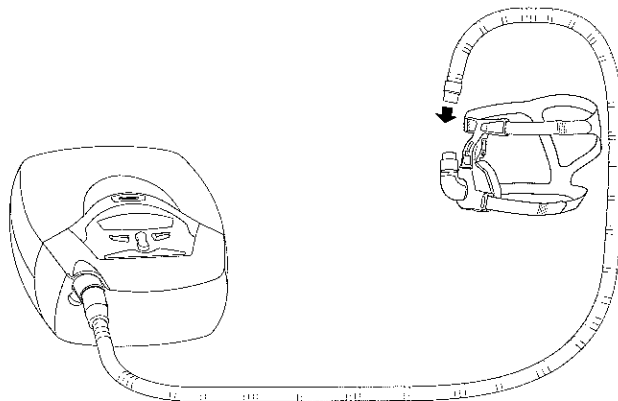

The RESMED S7 ELITE is now ready for use. To start treatment, see “Operating Instructions” on page 23.

HUMIDIFIER USE

HUMIDAIRE 2i

The HUMIDAIRE 2i attaches to the front of the RESMED S7 ELITE to provide heated humidification. No other accessories are required for its use. Please refer to the *HumidAire 2i User's Manual* for details.

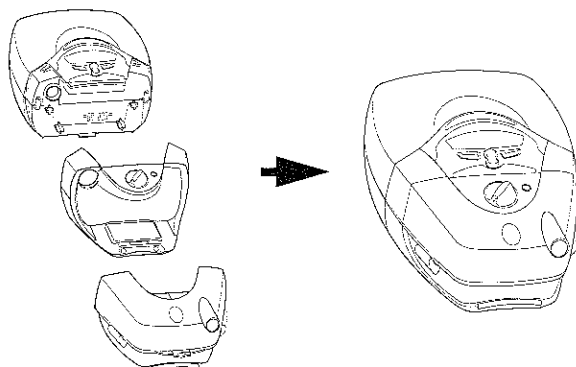

HUMIDAIRE 2iC

The HUMIDAIRE 2iC attaches to the front of a RESMED S7 ELITE unit to provide passover humidification. No other accessories are required for its use. Please refer to the *HumidAire 2iC User's Manual* for details.

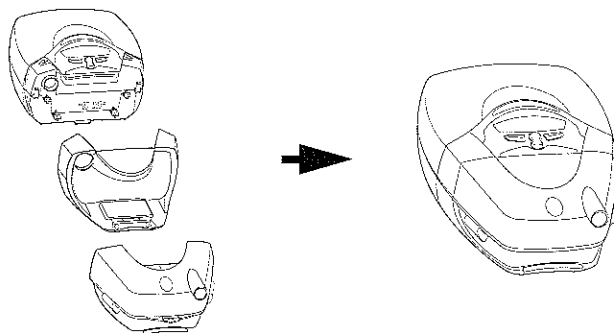

HUMIDAIRE AND PASSOVER

Short 7.5in (19cm) and medium size 21in (52cm) air tubing are necessary accessories for connecting the RESMED S7 ELITE unit to a HUMIDAIRE humidifier. Only the medium size tubing is needed for connecting to the RESMED PASSOVER.

To set up the RESMED S7 ELITE with the HUMIDAIRE or RESMED PASSOVER:

- 1 Fill the HUMIDAIRE or PASSOVER with water as described in the humidifier manual.

2 **HumidAire Users** Place the filled water chamber inside the HUMIDAIRE. Connect the medium 21 in (52cm) air tubing to the left connector port, and the short 7.5in (19cm) air tubing to the right connector port on the humidifier. Close the HUMIDAIRE lid.

ResMed Passover Users Connect the medium air tubing to the left connector on the PASSOVER.

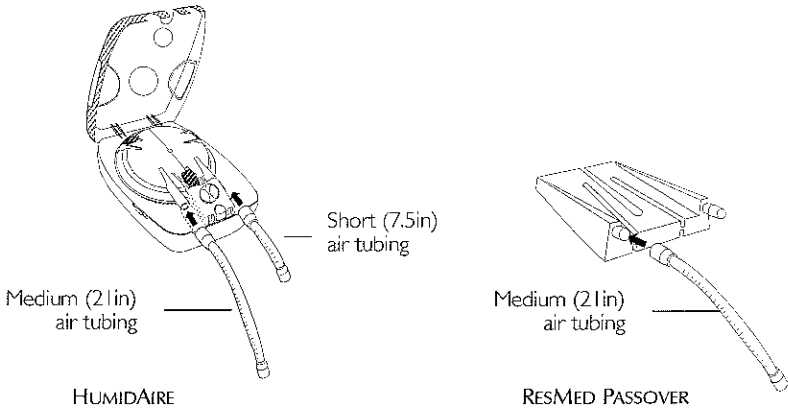

3 Place the RESMED S7 ELITE on top of the HUMIDAIRE or PASSOVER. Do not place the RESMED S7 ELITE unit underneath the humidifier. (This is to avoid water spilling into the RESMED S7 ELITE unit.)

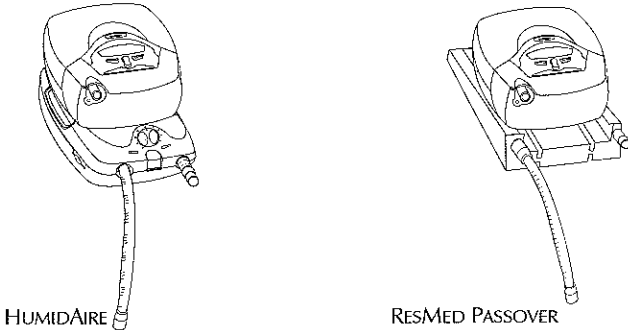

4 **HumidAire Users** Connect the free end of the medium air tubing to the air outlet of the RESMED S7 ELITE.

ResMed Passover Users Connect the free end of the air tubing to the air outlet of the RESMED S7 ELITE.

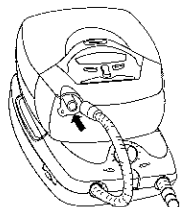

HUMIDAIRE

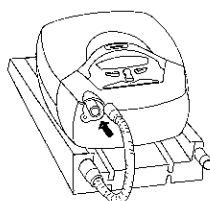

RESMED PASSOVER

- 5 **HumidAire Users** Take the pressure sensor line and press the air outlet connector onto the short air tubing.

ResMed Passover Users Take the pressure sensor line and press the air outlet connector onto the right connector port on the PASSOVER.

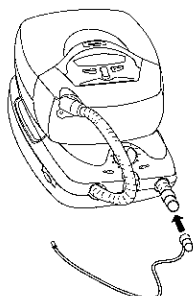

HUMIDAIRE

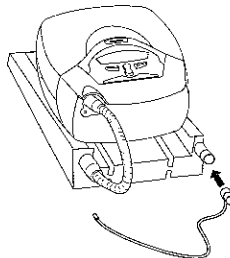

RESMED PASSOVER

**CAUTION**

Do not wash the pressure sensor line. It is not washable.

- 6 Connect the free end of the pressure sensor line firmly onto the pressure port of the RESMED S7 ELITE.

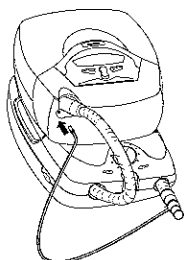

HUMIDAIRE

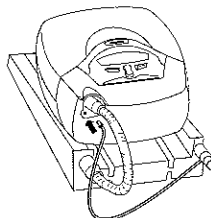

RESMED PASSOVER

- 7 Connect the long air tubing—6ft6in (2m) or 9ft10in (3m)—to the air outlet connector.

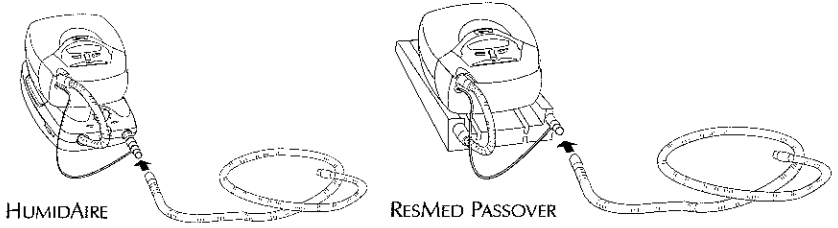

- 8 Assemble your mask system according to the mask user instructions.
- 9 Connect the mask system to the free end of the long air tubing. The final assembly should look like this:

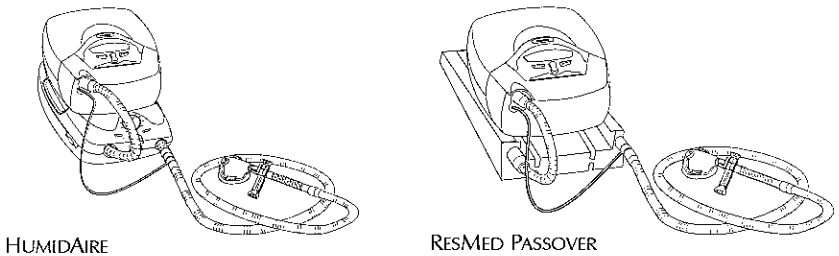

- 10 **HumidAire Users** Plug the HUMIDAIRE power cord into a power outlet.
- 11 Connect the power cord to the socket at the rear of the RESMED S7 ELITE. Plug the other end of the power cord into a power outlet.



WARNING

Make sure that the power cord and plug are in good condition and the equipment is not damaged.

- 12 The RESMED S7 ELITE is now ready for use with the HUMIDAIRE or the RESMED PASSOVER.



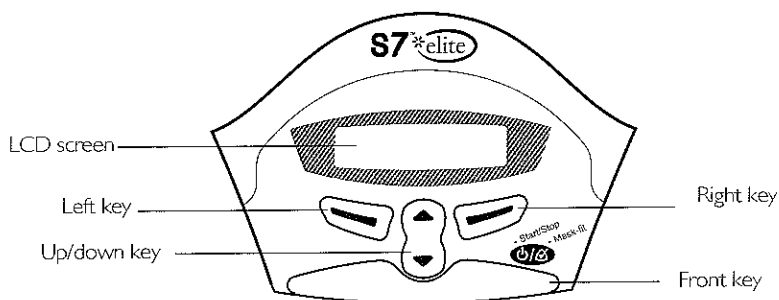

FEATURES OF THE RESMED S7 ELITE

LCD SCREEN AND KEYPAD

The control panel of the RESMED S7 ELITE includes an LCD screen and keypad

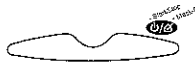

The RESMED S7 ELITE keypad has the following keys:

Key	Function
<p>Front</p> 	<ul style="list-style-type: none"> Starts or stops treatment. Extended hold for at least 3 seconds starts the mask-fitting feature.
<p>Up/Down</p> 	<ul style="list-style-type: none"> Allows you to scroll through the ResMed S7 ELITE menus, submenus, and setting options.
<p>Left</p> 	<ul style="list-style-type: none"> Performs the function indicated by the guiding text displayed above it on the LCD screen. Guiding text may include menu, enter, change, and apply.
<p>Right</p> 	<ul style="list-style-type: none"> Performs the function indicated by the guiding text displayed above it on the LCD screen. Guiding text may include exit and cancel.

To assist you in adjusting the RESMED S7 ELITE, the keypad and LCD are equipped with a backlight. The LCD backlight comes on when the unit is turned on or when you press a key, and turns off after 2 minutes. The keypad backlight is on at all times when the RESMED S7 ELITE is on.

USING THE MENUS

The RESMED S7 ELITE unit provides a set of functions which are arranged in menus and submenus. Via the LCD screen, the menus and submenus allow you to view and change the settings for a particular function. You can access the menus when the RESMED S7 ELITE is in standby mode.

MENU TYPE

Depending on the type of menu that your clinician has set your machine to, either a *standard* menu or a *detailed* menu appears.

The standard menu allows you to view details about the current software version and usage time of your RESMED S7 ELITE. The Used screen displays the total number of days and/or hours for which the RESMED S7 ELITE has been used.

The detailed menu allows you to view and change settings such as mask type, humidifier used, and the displayed language. You can also view the serial number, printed circuit board, and current software version of your RESMED S7 ELITE.

Note: *Your clinician may have customized your ResMed S7 Elite to display Smart Data. Contact your clinician for further details.*

Both types of menu allow you to view and change the ramping time.

Figure 1 summarizes the RESMED S7 ELITE standard menu series. Figure 2 summarizes the RESMED S7 ELITE detailed menu series.

ACCESSING THE MENUS

- To access the RESMED S7 ELITE menus:
Press the **Left** key (menu) while the standby (Ramp) screen is displayed.
- To scroll through items within a menu or submenu:
Press the **Up/Down** key.
- To enter a submenu (detailed menu only):
Press the **Left** key (enter).
- To change a setting option for a function:
 1. Press the **Left** key (change).
 2. Press the **Up/Down** key until the desired setting option appears.
 3. Press the **Left key** (apply) to select the setting option.
- To exit without changing options:
Press the **Right** key (cancel).
- To exit out of a menu or submenu:
Press the **Right** key (exit).

Note: *You can return to the standby screen at any time by holding down the Right key for at least 2 seconds.*

MENU FUNCTIONS

The RESMED S7 ELITE menu functions are summarized in Tables 1–3 below with a brief description of what each function does and the available setting options. To access these functions see “Using the Menus” on page 17.

STANDBY SCREEN

When you switch your RESMED S7 ELITE on, the Ramp (standby) screen is displayed after the Welcome screen. You can use the standby screen to select the ramp time. The ramp time is the period during which the RESMED S7 ELITE increases from a low comfortable pressure to the prescribed treatment pressure set by your clinician. You can set the ramp time from Off (0 minutes) to a possible maximum of 45 minutes, in increments of 5 minutes.

SETTINGS MENU (DETAILED MENU ONLY)

The Settings Menu allows you to view and change certain operating features of the RESMED S7 ELITE unit.

Table 1: Settings Menu Functions

Function	Function Description	Setting Options
Mask	Selects your mask type.	MIRAGE, MIR FULL (Full Face/Ultra Mirage Full Face Mask), STANDARD (Modular/Vista/Activa), ULTRA (Ultra Mirage)
Tube Length	Selects the length of air tubing connecting your mask to the ResMed S7 Elite.	6ft6in/9ft10in (2m/3m)
Humidifier	Selects the type of humidifier to be used with the ResMed S7 Elite.	NONE, PASSOVER*, HUMIDAIRE If the HumidAire 2i is used, the above setting options do not appear and HUMIDAIRE 2i is displayed.
SmartStart™	Turns the SmartStart function on or off. See “SmartStart™” on page 24.	ON/OFF
Leak Alert	Turns the Leak Alert signal on or off. If the Leak Alert signal is on, it alerts you when a high mask leak is detected, by sounding an audible tone and displaying a high leak message on the LCD screen. If the Leak Alert signal is off, a high leak message is displayed on the LCD screen when a high mask leak is detected. No audible tone is sounded.	ON/OFF

* Use the Passover setting if you have a HumidAire 2iC.

Note: If you select “Mir Full” as the mask option, SmartStart/Stop is automatically disabled. SmartStart does not work with a Mirage Full Face Mask due to safety features of the mask.

When Leak Alert is set to ON, SmartStart/Stop automatically reverts to OFF. SmartStop cannot be used with Leak Alert because if a high leak occurs, SmartStop will stop treatment before the Leak Alert signal is activated.

OPTIONS MENU (DETAILED MENU ONLY)

Table 2: Options Menu

Function	Function Description	Setting Options
Language	Selects the language the ResMed S7 Elite uses for all its display text. English is the default language.	English, German, French, Italian, Spanish, Portuguese, Swedish, Dutch.

SERVICING MENU (DETAILED MENU ONLY)

Table 3: Servicing Menu

Function	Function Description	Setting Options
Serial Number (SN)	Displays the serial number for the ResMed S7 Elite.	View only
Printed Circuit Board (PCB)	Displays the printed circuit board number.	View only
Software*	Displays the current software version installed in the ResMed S7 Elite.	View only

* Software version can be viewed in the standard menu as well.

OPERATING INSTRUCTIONS

STARTING TREATMENT

The RESMED S7 ELITE unit should be assembled beside your bed with the air tubing and mask system connected. See "Setting Up The ResMed S7 Elite" on page 11.

- 1 Turn the main power switch at the back of the unit to on (I).

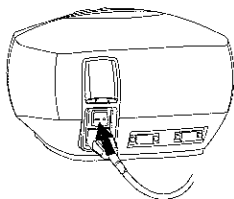

When the RESMED S7 ELITE is turned on, a welcome message is displayed on the LCD screen. The standby screen then appears.

Note: If you have the HumidAire 2i attached, please refer to the HumidAire 2i User's Manual for operating instructions.

- 2 Fit your mask as described in the mask user instructions.



WARNING

Before starting therapy ensure that you are wearing your mask and that the mask and air tubing are fitted correctly.

- 3 Lie down and arrange the air tubing so that it is free to move if you turn in your sleep.



CAUTION

- Do not leave long lengths of air tubing around the top of your bed. They could twist around your head or neck while you are sleeping.
- Make sure the area around the flow generator is dry and clean. It should also be clear of bedding, clothes, and other potential blockages.

- 4 To start treatment, press the **Front** key
or
if your clinician has enabled the SmartStart function, simply breathe into the mask and treatment will begin.
After starting treatment, the treatment pressure is displayed on the LCD.

Note: Pressure displayed on the LCD during therapy is the intended delivery pressure.

SMARTSTART™

The RESMED S7 ELITE has a function called SmartStart which can be enabled by your clinician. If SmartStart is enabled, the RESMED S7 ELITE will start automatically when you breathe into the mask and will stop automatically when you take your mask off. This means you do not have to press the **Front** key to begin or end treatment.

Note: Do not enable SmartStart when using a mask with an anti-asphyxia valve, such as the Mirage Full Face Mask.

STOPPING TREATMENT

To stop treatment at any time, remove your mask and press the **Front** key
or

if your clinician has enabled the SmartStart function, simply remove your mask and treatment will end.

USING THE MASK-FITTING FEATURE

The RESMED S7 ELITE mask-fitting feature can be used to help you fit your mask properly. The mask-fitting feature delivers air pressure for a three-minute period, prior to starting treatment, for checking and adjusting your mask fit to minimize leaks. To use the mask-fitting feature:

- 1 Fit your mask as described in the user instructions.

- 2 Hold down the **Front** key for at least 3 seconds until air pressure delivery starts. The following display will appear on the LCD screen indicating that the mask-fitting feature is in operation. The flow generator will ramp to the mask-fit pressure and will remain at this pressure for 3 minutes. A mask-fit star rating is also displayed. See "Definitions of Mask-Fit Star Rating" on page 25.



Note: The mask-fit star rating display disappears after 3 minutes.

The mask-fitting feature can only be started from the standby screen.

The mask-fit pressure is the set treatment pressure or 10 cm H₂O, whichever is greater.

- 3 Adjust your mask, mask cushion, and headgear until you have a secure and comfortable fit. Once you have a secure and comfortable fit, check your mask-fit star rating on the LCD screen. Definitions of the mask-fit star ratings are presented in Table 4.

Note: If there is another person nearby to check your mask-fit star rating, you can adjust your mask, mask cushion, and headgear while lying down.

- 4 After 3 minutes, the pressure will drop to the start pressure, and treatment will begin. (Except if Ramping is off, in which case the pressure will drop to the set pressure.) Definitions of the mask-fit star ratings are presented in Table 4.
- If you do not wish to wait 3 minutes, hold down the **Front** key for at least 3 seconds and treatment will begin immediately.
 - If you press the **Front** key for less than 3 seconds, the unit will return to standby mode (the Ramp screen is displayed).

Table 4: Definitions of Mask-Fit Star Rating

Star rating	Definition
*****	Excellent
****_	Very good
***_ _	Good
**_ _ _	Adjust mask
*_ _ _ _	Adjust mask
_ _ _ _ _	Adjust mask

HELPFUL HINTS

STARTING OUT

FIRST USE

When you first use your RESMED S7 ELITE unit, you may feel uncomfortable breathing against the air flow. This is normal. You will continue to breathe normally while you sleep. Take time to adjust to this new sensation. Taking a few deep breaths may help.

GETTING UP

If you need to get up during the night, remove your mask and turn the flow generator off. Always remember to put your mask on and turn your flow generator on when you return to bed.

MOUTH LEAKS

If using a nasal mask, try to keep your mouth closed during treatment. Air leaks from your mouth can decrease the effectiveness of your treatment. If mouth leaks are a problem, a full face mask or chin strap may help. Contact your clinician or equipment supplier for further details.

MASK FITTING

The flow generator delivers the most effective treatment when the mask is well fitted and comfortable. Treatment can be affected by leaks, so it is important to eliminate any leaks that may arise.

If you have problems trying to get a comfortable mask fit, contact your sleep clinic or equipment supplier. You may benefit from a different size or style of mask.

You can also use the mask-fitting feature to help you fit your mask properly. See “Using the Mask-Fitting Feature” on page 24.

Before wearing your mask, wash your face to remove excess facial oils. This will allow a better fit and prolong the life of the mask cushion.

NASAL IRRITATION

DRYNESS

You may experience dryness of the nose, mouth, and/or throat during the course of treatment, especially during winter. In many cases, a humidifier may resolve this discomfort. Contact your clinician for advice.

RUNNY OR BLOCKED NOSE

You may experience sneezing and/or a runny or blocked nose during the first few weeks of treatment. In many cases, nasal irritation can be resolved with a humidifier. Consult your clinician for advice.

TRAVELLING WITH THE RESMED S7 ELITE

INTERNATIONAL USE

Your RESMED S7 ELITE flow generator has an internal power adapter that enables it to operate in other countries. It will operate on power supplies of 100–240V and 50–60Hz. No special adjustment is necessary, but you may need a plug adapter for the power outlet.

CLEANING AND MAINTENANCE

You should regularly carry out the cleaning and maintenance described in this section.



WARNING

- Do not wash the pressure sensor adapter.
- Do not wash the pressure sensor line that is used with the HUMIDAIRE or the RESMED PASSOVER.

DAILY

1. Disconnect the air tubing and hang it in a clean, dry place until next use. Do not hang the air tubing in direct sunlight as it may harden and crack over time.
2. Clean the mask according to the mask user instructions.
3. If you are using a humidifier, clean it according to the instructions in the manual.

WEEKLY

1. Remove the air tubing from the RESMED S7 ELITE unit *and* the mask.
2. Wash the mask system according to the instructions supplied with it.
3. Wash the air tubing in warm water using mild detergent. Rinse thoroughly, hang and allow to dry.
4. Before next use, assemble the mask and headgear according to the mask user instructions.
5. Reconnect the air tubing to the pressure sensor adapter and mask.



CAUTION

- Do not use bleach, chlorine-, alcohol- or aromatic-based solutions (including all scented oils), moisturizing, or antibacterial soaps to clean the cushion, mask, air tubing, or the RESMED S7 ELITE. These solutions may cause hardening and reduce the life of the product.
- Do not wash or dry the mask frame at a temperature above 176°F (80°C). Exposure to higher temperatures may reduce the life of the product.
- Do not hang the air tubing and pressure sensor adapter in direct sunlight as the tubing may harden over time and eventually crack.

PERIODICALLY

1. The mask and air tubing are subject to normal wear and tear. Inspect them regularly for damage.
2. Clean the exterior of the flow generator with a damp cloth and mild detergent.
3. Inspect the air filter to check if it is blocked by dirt or contains holes. See "Replacing the Air Filter" on page 28.
4. Replace the pressure sensor adapter every 12 months.



WARNING

Beware of electric shock. Do not immerse the flow generator or power cord in water. Always unplug the flow generator before cleaning and be sure that it is dry before reconnecting.



CAUTION

Do not attempt to open the RESMED S7 ELITE. There are no user serviceable parts inside. Repairs and internal servicing should only be performed by an authorized service agent.

REPLACING THE AIR FILTER

Inspect the air filter every month to check if it is blocked by dirt or contains holes. With normal use of a RESMED S7 ELITE unit, the air filter needs to be replaced every six months (or more often if your unit is in a dusty environment). To replace the air filter:

1. Remove the air filter cover at the back of the RESMED S7 ELITE.

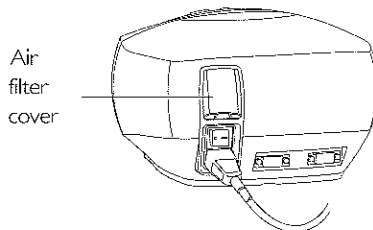

2. Remove and discard the old air filter.
3. Insert a new filter with the blue tinted side facing out from the unit.
4. Replace the air filter cover.



WARNING

Do not wash the air filter. The air filter is not washable or reusable.

Note: *The air filter should be inspected once a month.*

SERVICING

Your RESMED S7 ELITE flow generator is designed to give you years of trouble-free operation.

The flow generator should not require regular servicing if it is maintained according to the instructions in this manual. If you feel that your unit is not performing properly, see "Troubleshooting" on page 29.



CAUTION

Inspection and repair should only be performed by an authorized agent.

Under no circumstances should you attempt to service or repair the flow generator yourself.

TROUBLESHOOTING

If there is a problem, try the following suggestions. If the problem cannot be solved, contact your equipment supplier or ResMed. Do not attempt to open the unit.

Problem	Possible Cause	Solution
<i>No display.</i>	Power not connected or switch at back is not on.	Ensure the power cable is connected and that the switch at the back of the unit is in the ON position.
<i>Insufficient air delivered from the ResMed S7 Elite.</i>	Ramp Time is in use.	Wait for air pressure to build up.
	Air filter is dirty.	Replace air filter.
	Air tubing is kinked or punctured.	Straighten or replace tubing.
	Air tubing not connected properly.	Check air tubing.
	Mask and headgear not positioned correctly.	Adjust position of mask and headgear.
<i>The ResMed S7 Elite does not start when you breathe into the mask.</i>	Plug(s) missing from access port(s) on mask.	Replace plug(s).
	Pressure required for treatment may have changed.	See your clinician to adjust the pressure.
	Power cord not connected properly.	Connect power cord firmly at both ends.
	Power outlet may be faulty.	Try another power outlet.
	The ResMed S7 Elite unit not switched on.	Switch power switch at rear of the ResMed S7 Elite to ON.
	SmartStart not on.	Enable SmartStart.
	Leak Alert has been enabled; SmartStart has automatically been disabled.	Disable Leak Alert to enable SmartStart.
	Use of a Mirage Full Face Mask.	SmartStart does not work with a full face mask as the anti-asphyxia valve will not allow sufficiently high pressure on exhalation.
	Breath is not deep enough to trigger SmartStart.	Take a deep breath in and out through the mask.
	There is excessive leak.	Adjust position of mask and headgear.
	Plugs may be missing from ports on mask. Replace them.	
	Air tubing not connected properly. Connect firmly at both ends.	
	Air tubing kinked or punctured. Straighten or replace.	

Problem	Possible Cause	Solution
<i>The ResMed S7 Elite unit does not stop when you remove your mask.</i>	SmartStart/Stop is disabled.	Enable SmartStart/Stop.
<i>SmartStart is enabled but the flow generator does not stop automatically when you remove your mask.</i>	Incompatible humidifier or mask system being used.	Use only equipment as recommended and supplied by ResMed.
<i>Display error message: Check tube!! Key if done</i>	The air tubing is loose.	Check that the air tubing is connected securely to your mask and the air outlet on the front of the ResMed S7 Elite. When you have checked the air tubing, press the Front key to restart the machine. If this does not clear the message, turn the power switch off and then turn it back on to restart the machine.
<i>Display error message: SYSTEM ERROR Call service!</i>	Component failure.	Turn your ResMed S7 Elite off and then turn it back on. If the error message is still displayed, return the device for servicing.
<i>Display error message: High leak in last session</i>	You have experienced excessively high leak levels during the night.	Check that your air tubing is connected properly and that your mask does not leak excessively. Use the mask-fitting feature to help you to fit your mask properly. If this message appears again, contact your clinician.

SYSTEM SPECIFICATIONS

Performance: Operating pressure range: 4 to 20 cm H₂O

Dimensions (H x W x D): 5.6in x 9.1in x 10.6in (141mm x 230mm x 270mm)

Weight: 5.1lb (2.3kg)

Power Supply

Input range 100–240V, 50–60Hz, < 120VA (maximum power consumption)

Actual power consumption will vary, depending on factors such as the use of accessories, height above sea level, and ambient temperature. Power consumption values for typical treatment conditions (using a breathing machine set to 0.5L and 15 breaths/min with 6ft6in (2m) air tubing and a modular mask) are given in the following table.

Device	Pressure (cmH ₂ O)	Power (VA)
ResMed S7 Elite	5	20
	10	26
	15	32
	20	39

Housing Construction: Flame retardant engineering thermoplastic

Environmental Conditions

Operating Temperature: +41°F (+5°C) to +104°F (+40°C)

Operating Humidity: 10%–95% non-condensing

Storage and Transport Temperature: -4°F (-20°C) to +140°F (+60°C)

Storage and Transport Humidity: 10%–95% non-condensing

Electromagnetic Compatibility

Product complies with all applicable electromagnetic compatibility requirements (EMC) according to IEC60601-1-2, for residential, commercial, and light industry environments.

Air Filter: Two-layered, powder-bonded, polyester non-woven fiber

Air Tubing: Flexible plastic, 6ft6in (2m) or 9ft10in (3m) length

Pressure Sensor Adapter: Thermoplastic rubber

IEC 60601-1 Classifications: Class II (double insulation), Type CF

Note: The manufacturer reserves the right to change these specifications without notice.

GLOSSARY OF SYMBOLS



Attention, consult accompanying documents



Type CF applied part



Class II equipment



IPX1

Drip Proof



Start/Stop or Mask-fit

FLOW/PRESSURE CHARACTERISTICS

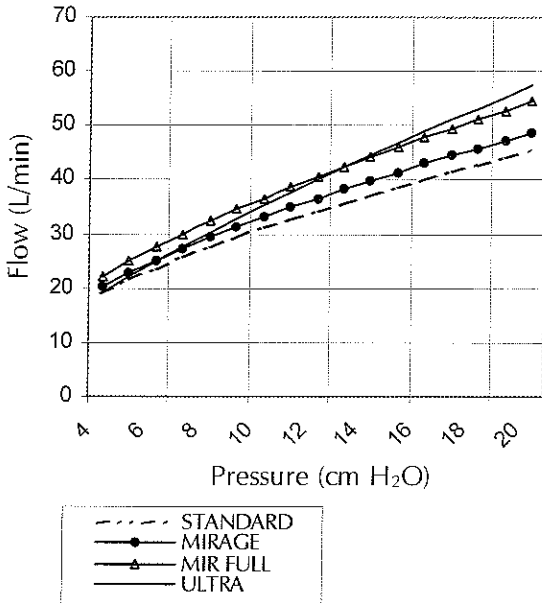

LIMITED WARRANTY

ResMed warrants that your ResMed product shall be free from defects in material and workmanship for the period specified below from the date of purchase by the initial consumer.

Product	Warranty Period
AutoSet CS™ flow generator, ResMed humidifiers, ResControl™, ResLink™.	1 Year
CPAP (continuous positive airway pressure), APAP (automatic positive airway pressure), bilevel, and AutoSet CS™ 2 flow generators.	2 Years
Accessories, mask systems (including mask frame, cushion, headgear and tubing). Excludes single-use devices.	90 Days

Note: *Some models are not available in all regions.*

If the product fails under conditions of normal use, ResMed will repair or replace, at its option, the defective product or any of its components. This Limited Warranty does not cover: a) any damage caused as a result of improper use, abuse, modification or alteration of the product; or b) repairs carried out by any service organization that has not been expressly authorized by ResMed to perform such repairs. Any product repaired or replaced under warranty will be returned, freight prepaid, to the dealer designated by the consumer. The cost of transporting the product to an authorized service organization will be borne by the consumer.

This warranty is in lieu of all other express or implied warranties, including any implied warranty of merchantability or fitness for a particular purpose. Some regions or states do not allow limitations on how long an implied warranty lasts, so the above limitation may not apply to you.

ResMed shall not be responsible for any incidental or consequential damages claimed to have occurred as a result of the sale, installation or use of any ResMed product. Some regions or states do not allow the exclusion or limitation of incidental or consequential damages, so the above limitation may not apply to you. This warranty gives you specific legal rights, and you may also have other rights which vary from region to region.

For further information on your warranty rights, contact your local ResMed dealer or ResMed office.

R000-303/6 03 08

INDEX

A

Accessories 9
Air Filter 28, 31
Air Tubing 31

B

Backlight, LCD, and Keypad 17

C

Cleaning and Maintenance 27
Cleaning Periodically 27
Components 7

D

Daily Cleaning 27
Definitions 3
Detailed Menu 18
Dimensions 31
Dryness 26

E

Electromagnetic Compatibility 31
Environmental Conditions 31
Error Messages 30

F

Features of the ResMed S7 Elite 17
First Use 25
Flow/Pressure Characteristics 32
Front Key 17

G

Getting Up 25
Glossary of Symbols 32

H

Helpful Hints 25
High Leak Message 20
Housing Construction 31
HumidAire 2i 13
HumidAire 2iC 13
Humidifier 8, 13
Humidifier Use 13

I

IEC 60601-1 Classifications 31
International Use 26

K

Keys, functions 17

L

LCD Screen and Keypad 17
Leak Alert 20
Left Key 17

M

Mask Fitting 25
Mask-fit Star Rating, definitions 25
Mask-fitting Feature 24
Masks 8
Medical Information 3
Menu Functions 20
Menu Type 18
Menus, using the ResMed S7 Elite 17
Mouth Leaks 25

N

Nasal Irritation 26

O

Operating Instructions 23
Options 21
Options Menu 21
Oxygen Use 5

P

Passover 13
Performance 31
Power Supply 31
Preparing for Use 11
Pressure Sensor Adapter 31

R

Replacing the Air Filter 28
Responsibility, user/owner 3
Right Key 17
Runny or Blocked Nose 26

S

Servicing 28
Servicing Menu 21
Setting Up 11
Settings Menu 20
Side Effects 6
SmartStart 24

Standard Menu 18, 19
Starting Treatment 23
Stopping Treatment 24
System Specifications 31

T

Travelling 26
Troubleshooting 29

U

Up/Down Key 17
Used Screen 18
User/Owner Responsibility 3
Using the Mask-fitting Feature 24
Using the Menus 17

W

Warnings Related to Treatment 5
Weekly Cleaning 27
Weight 31