











# *Table of Contents*

<b>Symbol Key</b> .....	2
<b>Intended Use &amp; Contraindications</b> .....	3
<b>Specifications</b> .....	4
<b>Warnings &amp; Cautions</b> .....	5
<b>System Features</b> .....	7
<b>First Time Setup</b> .....	8
○ Installing the Filter .....	9
○ Device Settings .....	10
○ Assembling the Circuit .....	13
<b>Accessories</b> .....	14
○ Adding a Humidifier .....	14
○ Adding Oxygen to the System .....	14
○ Using DC Power .....	15
○ Using an Ultra-fine Filter .....	15
○ Carrying Case .....	15
<b>Routine Use</b> .....	16
○ Connecting the Circuit .....	16
○ Adjusting the Circuit .....	16
○ Ramp Button .....	17
○ Turning the System Off .....	17
○ Helpful Hints .....	17
<b>Traveling with the System</b> .....	18
<b>Routine Maintenance</b> .....	19
○ Cleaning the Filter .....	19
○ Cleaning the System .....	19
○ Reordering .....	20
○ Service .....	20
<b>Troubleshooting</b> .....	21
<b>Warranty</b> .....	23

# SYMBOLS









## Display Screen

-  Attention is needed
-  Patient disconnect alert enabled or setting is shown
-  SmartCard is installed
-  Button Lights are ON or setting is shown
-  Humidifier is ON or humidifier setting is shown
-  Ramp start pressure setting is shown
-  Ramp pressure is being delivered
-  FOSQ test questions are shown
-  Centimeters of water (displayed with pressure readings or settings)
-  Hours of use
-  Number of nights with more than 4 hours usage

## Control Buttons

-  Pressure On / Off
-  Ramp Start
-  Humidifier On / Off

## REMstar Auto Device

-  Attention, Consult Accompanying Documents
-  DC Power
-  AC Power
-  Type BF Applied Part
-  Class II (Double Insulated)
- IPX0** Ordinary Equipment Rating
-  European CE Declaration of Conformity
-  Notified Body Approval for Standards Compliance
-  Canadian/US Certification

## **Intended Use**

The Respironics REMstar Auto System is a CPAP (Continuous Positive Airway Pressure) device designed for the treatment of adult Obstructive Sleep Apnea (OSA) only.

The REMstar Auto is to be used only on the instruction of a licensed health care professional. The system can deliver CPAP therapy or Auto-CPAP therapy. Your home care provider will make the correct pressure settings according to your health care professional's prescription.

When set in the Auto-CPAP mode, the system will monitor your breathing as you sleep and automatically adjust the pressure to meet your needs. When in the CPAP mode, the system will deliver a continuous, set pressure during the night.

Several accessories are available to make your OSA treatment with the REMstar Auto CPAP System as convenient and comfortable as possible. To ensure that you receive the safe, effective therapy prescribed for you, use only Respironics accessories.

***IMPORTANT!*** *Read and understand the entire user's manual before operating this system. If you have any questions concerning the use of this system, contact your home care provider or health care professional.*

## **Contraindications**

Studies have shown that the following pre-existing conditions may contraindicate the use of positive airway pressure therapy for some patients:

- Bullous Lung Disease
- Bypassed Upper Airway
- Pneumothorax
- Pathologically Low Blood Pressure
- Pneumocephalus has been reported in a patient using nasal Continuous Positive Airway Pressure. Caution should be used when prescribing CPAP for susceptible patients such as those with: cerebral spinal fluid (CSF) leaks, abnormalities of the cribriform plate, prior history of head trauma, and/or pneumocephalus. (Chest 1989; 96:1425-1426)

The use of positive airway pressure therapy may be temporarily contraindicated if you exhibit signs of a sinus or middle ear infection. Contact your health care professional if you have any questions concerning your therapy.

# Specifications

<b>Device Size</b>	<b>Dimensions:</b> 9 1/2" x 6 7/8" x 4 1/2" (24 x 17 x 12 cm) <b>Weight:</b> <4.0 lbs. (<1.8 kg)												
<b>Product Use, Transport, and Storage</b>	<table><thead><tr><th></th><th><b>Operation</b></th><th><b>Transport &amp; Storage</b></th></tr></thead><tbody><tr><td><b>Temperature:</b></td><td>41 to 95° F (5 to 35° C)</td><td>-4 to 140° F (-20 to 60° C)</td></tr><tr><td><b>Humidity:</b></td><td>15 to 95% Non-condensing</td><td>15 to 95% Non-condensing</td></tr><tr><td><b>Atmospheric Pressure:</b></td><td>83 to 102 kPascals</td><td>N/A</td></tr></tbody></table>		<b>Operation</b>	<b>Transport &amp; Storage</b>	<b>Temperature:</b>	41 to 95° F (5 to 35° C)	-4 to 140° F (-20 to 60° C)	<b>Humidity:</b>	15 to 95% Non-condensing	15 to 95% Non-condensing	<b>Atmospheric Pressure:</b>	83 to 102 kPascals	N/A
	<b>Operation</b>	<b>Transport &amp; Storage</b>											
<b>Temperature:</b>	41 to 95° F (5 to 35° C)	-4 to 140° F (-20 to 60° C)											
<b>Humidity:</b>	15 to 95% Non-condensing	15 to 95% Non-condensing											
<b>Atmospheric Pressure:</b>	83 to 102 kPascals	N/A											
<b>Standards Compliance</b>	<b>This device is designed to conform to the following standards:</b> <b>IEC 60601-1 General Requirements for Safety of Medical Electrical Equipment</b> <b>prEN ISO 17510-1 Sleep Apnea Breathing Therapy Devices</b>												
<b>Mode of Operation</b>	Continuous												
<b>Power Requirements</b>	<b>AC Power Consumption:</b> 100 - 240 VAC, 50/60 Hz, 1.0 A max. <b>DC Power Consumption:</b> 12 VDC, 3.0 A max.												
<b>Type of Protection Against Electric Shock</b>	Class II Equipment												
<b>Degree of Protection Against Electric Shock</b>	Type BF Applied Part												
<b>Degree of Protection Against Ingress of Water</b>	IPX0 - Ordinary Equipment												
<b>Pressure Range</b>	4 to 20 cm H <sub>2</sub> O (in 0.2 cm increments)												
<b>Pressure Stability</b>	4 to 10 cm H <sub>2</sub> O (±0.7 cm H <sub>2</sub> O) >10 to 20 cm H <sub>2</sub> O (±1.0 cm H <sub>2</sub> O) Measured in accordance with prEN 17510 @ 6.6, 13.2, & 20 cm H <sub>2</sub> O @ 500 ml with BPM set to 10, 15, & 20 BPM performed at 23° C (±2° C), 50% RH (±5%), and an atmospheric pressure of 101.54 kPascals.												
<b>Sound Pressure Level</b>	<37 dB(A) Measured in accordance with prEN 17510 @ 10 cm H <sub>2</sub> O at the patient circuit. This measurement applies to the CPAP device with or without the optional REMstar Heated Humidifier.												
<b>Maximum Flow</b>	35 LPM Measured in accordance with prEN 17510 @ 6.6, 13.2, & 20 cm H <sub>2</sub> O @ 500 ml with BPM set to 10, 15, & 20 BPM performed at 23° C (±2° C), 50% RH (±5%), and an atmospheric pressure of 101.54 kPascals.												

# Warnings & Cautions

## **CAUTION!**

- *US federal law restricts this device to sale by or on the order of a physician.*

## **WARNING!**

Indicates the possibility for injury to the user or the operator.

- *The instructions in this manual are not intended to supersede established medical protocols.*
- *This device is intended for adult use only.*
- *This device is not intended for life support.*
- *CPAP devices have the potential to allow rebreathing of exhaled air. To reduce this potential, observe the following:*
  - *Use Respironics circuit accessories.*
  - *Do not wear the mask and headgear for more than a few minutes while the device is not operating.*
  - *Do not block or try to seal the vent holes in the exhalation port.*

*As with most CPAP devices: At low CPAP pressures, some exhaled gas (CO<sub>2</sub>) may remain in the mask and be rebreathed.*

- *Do not use this device if the room temperature is warmer than 95° F (35° C). If this device is used at room temperatures warmer than 95° F (35° C), the temperature of the airflow may exceed 106° F (41° C). This could cause irritation to your airway.*
- *This equipment is not suitable for use in the presence of a flammable anaesthetic mixture in combination with oxygen or air, or in the presence of nitrous oxide.*
- *If you notice any unexplained changes in the performance of the REMstar Auto, if it is making unusual or harsh sounds, if it has been dropped or mishandled, if the enclosure is broken, or if water has entered the enclosure, disconnect the power cord and discontinue use. Contact your home care provider.*
- *To avoid electrical shock, disconnect the power cord before cleaning. DO NOT immerse the device in any fluids.*
- *Contact your health care professional if symptoms of sleep apnea recur.*

## **CAUTION!**

Indicates the possibility of damage to the device.

- *Tobacco smoke may cause tar build-up within the REMstar Auto that may result in the REMstar Auto malfunctioning.*

**Additional warnings and cautions are located throughout this manual as they apply.**

# Unpacking the System

After unpacking the system, make sure you have everything shown here:

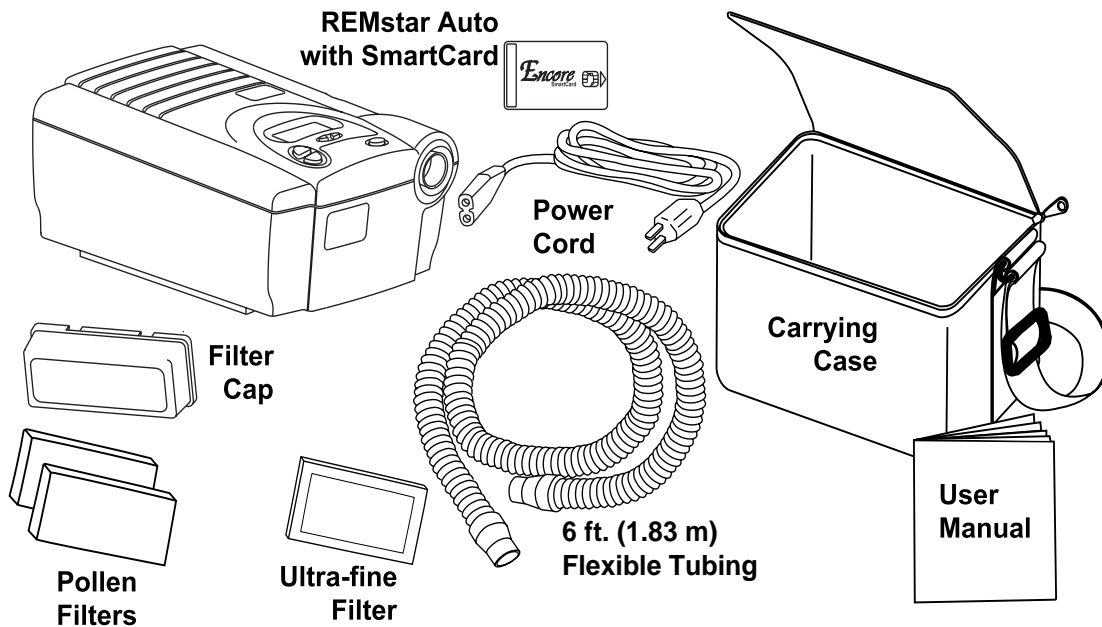

**IMPORTANT!** *If any of the above parts are missing, contact your home care provider.*

The Encore SmartCard is a feature that records CPAP usage. Another feature is the FOSQ “Quality of Life” questionnaire. Your health care professional or home care provider may ask you to periodically complete this questionnaire and send in your answers (recorded on the SmartCard). The FOSQ questionnaire is detailed in the enclosed “Sleep Solutions” brochure.

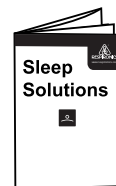

# System Features

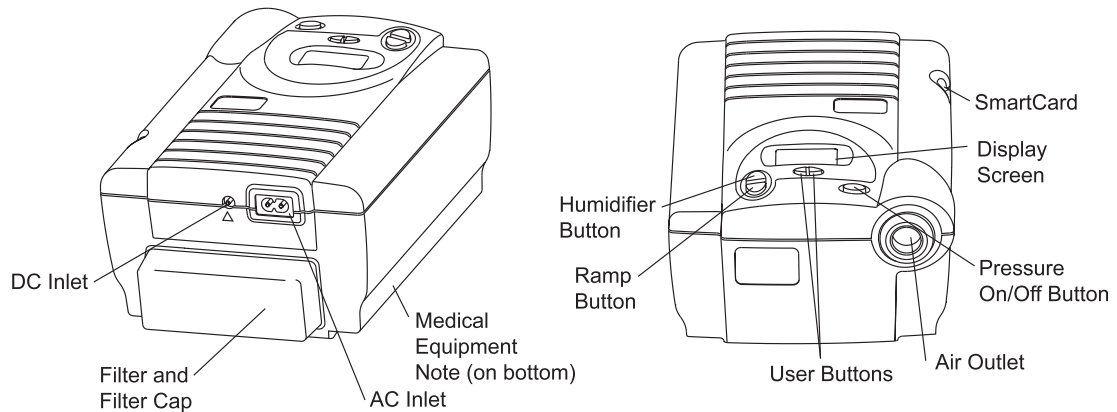

**AC Inlet** ..... Connect/disconnect the AC power cord here.

**Air Outlet** ..... Connect the flexible tubing here.

**DC Inlet** ..... Connect the optional DC power cord here.

**Display Screen** ..... All system settings, total operating time, and therapy hours will appear here. Displays the pressure settings.

**Filter Cap & Filters** ..... The pollen filter screens out normal household dust and pollens. The optional, ultra-fine filter is also included for more complete filtration of very fine particles. The filter cap is designed to reduce the noise from the REMstar Auto.

**Humidifier Button** ..... This button turns the REMstar heated humidifier on/off and allows the heat setting to be adjusted. The humidifier is an optional accessory that may be purchased separately.

**Medical Product Note** ..... For ease at airport security stations, there is a note on the bottom of the REMstar Auto stating that it is medical equipment. It may help if you also take this manual with you when you travel.

## Pressure On / Off

**Button** ..... This button turns the airflow on or off.

**Ramp Button** ..... This button starts the ramp cycle or accesses the REMstar Auto settings.

**SmartCard** ..... The SmartCard records device usage information (e.g., length of time the system was used for therapy). Contact your home care provider for further information about the SmartCard.

**User Buttons** ..... These buttons can be used to change some of the system settings and to answer the FOSQ quality of life questionnaire.

# First Time Setup

**WARNING!** Do not use the REMstar Auto System until an appropriate professional adjusts the settings! To order any accessories not included with this System, contact your home care provider.

*Note to home care provider: Before beginning setup, be sure that you have available the REMstar Auto Home Care Provider Setup Instructions. Setup instructions are not provided in this manual.*

**WARNING!** DO NOT connect any equipment to the REMstar Auto unless recommended by Respirationics or your health care provider.

**WARNING!** Respirationics circuit accessories (i.e., nasal mask, exhalation port, tubing) are for single patient use only and are not intended to be used on multiple patients.

**CAUTION!** If the REMstar Auto has been exposed to either very hot or very cold temperatures, allow it to adjust to room temperature (approximately 2 hours) before beginning setup.

## SmartCard

The REMstar Auto comes with a SmartCard installed in the side of the device to record information for the home care provider. Your home care provider may ask you to periodically remove the SmartCard and send it to him for evaluation.

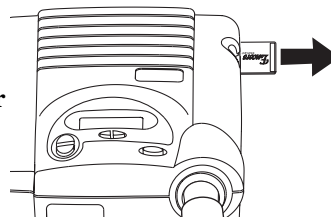

**ATTENTION!** The SmartCard does not need to be installed for the REMstar Auto to work properly. The SmartCard records device usage information for use by your home care provider. Contact your home care provider if you have any questions about the SmartCard.



# First Time Setup

## Installing the Filter

### CAUTION!

*The pollen filter must be in place at all times when the REMstar Auto is operating. The white ultra-fine filter is optional and can be used in addition to the pollen filter. The ultra-fine filter is recommended for people who are sensitive to tobacco smoke or other small particles.*

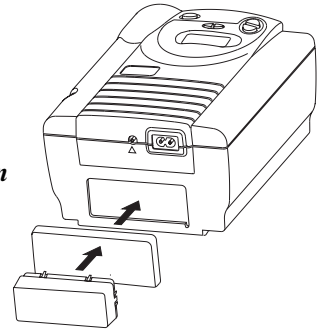

1. Install the filters and filter cap.

- a. Place one of the pollen filters over the ultra-fine filter. If you are not using the ultra-fine filter, simply place the pollen filter into the filter area on the back of the REMstar Auto. An extra filter is included for your convenience.
- b. Attach the filter cap. Position the cap so that the small opening on the cap is facing down. Insert the cap's tabs into the filter area opening.

## Power Cord

2. Connect the power cord. Plug the socket end of the power cord into the AC inlet on the back of the REMstar Auto. Plug the pronged end of the power cord into an electrical outlet.

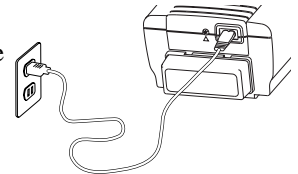

### IMPORTANT!

*To remove AC power, disconnect the power cord from the electrical outlet.*

### WARNING!

*Inspect the power cord often for any signs of damage. Replace a damaged cord immediately.*

### WARNING!

*The REMstar Auto is activated and ready for use when the power cord is connected. The Pressure On / Off button turns the blower on/off.*

3. Place the REMstar Auto on a firm, flat surface.

### CAUTION!

*Make sure the REMstar Auto is away from any heating or cooling equipment (e.g., forced air vents, radiators, air conditioners). Also make sure that bedding, curtains, or other items are not blocking the filter or vents of the device. Air must flow freely around the device for the system to work properly.*

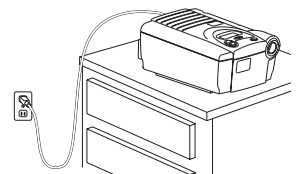

# First Time Setup

## Device Settings

Once the power cord is plugged in, the hourglass symbol and the hours of use will appear. The SmartCard symbol in the lower right corner of the display screen signifies that the SmartCard is installed.

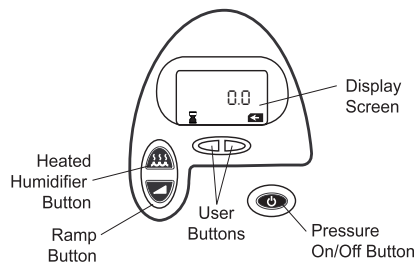

**Display Screen:** All device settings will appear here.

**Pressure On/Off Button:** Use this button to turn the airflow on or off. DO NOT turn the airflow on until the circuit tubing is connected.

**Heated Humidifier Button:** Use this button when the optional REMstar Heated Humidifier has been prescribed. This button will control the optional heated humidifier's output. Follow the instructions included with the humidifier.

**Ramp Button:** When the airflow is turned on, use this button to temporarily reduce the pressure. When the airflow is turned off, use this button to access the patient menu.

**Auto-CPAP Mode** - Pressing the button will reduce the pressure and then automatically increase the pressure during the night to the appropriate level to meet your needs.

**CPAP Mode** - If your health care professional prescribed ramp for you, you can press the button to reduce the pressure and then gradually increase (ramp) the pressure to the therapeutic pressure setting so that you can fall asleep more comfortably. *Note: The ramp feature is not prescribed for all users.*

**User Buttons:** These buttons can be used when entering various menus to change some of the REMstar Auto settings.

## IMPORTANT!

*In the Setup Menu, the humidifier and ramp buttons operate as up and down keys to change the settings, the left / right user buttons are used to go to the next / previous question or setting, and the pressure on/off button will allow you to exit the Setup Menu.*

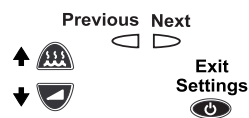

# First Time Setup

## Device Settings

4. **Verify/Change the REMstar Auto settings.** To start the setup menu, press and hold the ramp button. (The airflow must be turned off.)

**IMPORTANT!** *Pressing the ramp button (when the airflow is turned on) will lower the airflow pressure, if prescribed.*

**WARNING!** *DO NOT use the REMstar Auto if the display is erratic. Contact your home care provider for further instructions.*

## Therapy Hours

- a. **The number of nights the REMstar Auto was used for therapy for more than 4 hours will appear.** This screen is only for reference. Your home care provider may periodically ask you for this information.



**To continue with the settings, press the right user button.**

## FOSQ

- b. **The FOSQ symbol will appear and blink.**

*Note: This symbol will only appear if the SmartCard has been installed. If the SmartCard is not installed, go to Step c.*



The FOSQ test is a “quality of life” questionnaire designed specifically for people with sleep disorders. The results allow health care professionals to see how therapy has improved the quality of your life. The REMstar Auto has the ability to record your answers on the SmartCard for later review by the health care professional. Contact your home care provider for further instructions.

*If your health care professional or home care provider instructs you to complete the questionnaire, he will provide you with the instructions and the questions, and you will enter your answers into the REMstar Auto. Make sure the SmartCard is installed before answering the questions.*

**To continue with the settings, press the right user button.**

# First Time Setup

## Turning the Alert Tone On or Off

- c. **The Patient Disconnect Alert symbol will appear and blink.** This setting is a beeping sound that the REMstar Auto makes when a large, continuous air leak has been detected in the circuit and lasts for 45 seconds. You have the option of turning the alert tone on or off.



1 = on                      0 = off

**To change the setting, press the ramp or humidifier button. Press the right user button to go to the next setting.**

## Setting the Button Lights

- d. **The button lights symbol will appear and blink.** This setting allows you to have the lights behind the buttons turned on or off while the airflow is turned on. (The lights will always be on when the airflow is off.)



1 = on                      0 = off

**To change the setting, press the ramp or humidifier button. Press the right user button to go to the next setting.**

## Setting the Minimum Ramp Pressure

- e. **The ramp starting pressure symbol will appear and blink.**  
*Note: This symbol will only appear if your health care professional prescribed ramp for you. If ramp was not prescribed, press the pressure on/off button to exit the settings.*



The ramp feature will reduce the pressure and then gradually increase (ramp) the pressure to the prescription pressure setting so that you can fall asleep more comfortably.

Your home care provider will have already set a ramp starting pressure. If you feel the ramp starting pressure is set too low or too high, you can change the setting. (Range: 4 cm H<sub>2</sub>O - Prescription Pressure)

**To change the setting, press the ramp or humidifier button. (You can hold the button down to make the setting change faster.) Press the pressure on/off button to exit the settings.**

# First Time Setup

## Assembling the Circuit

5. **Assemble the circuit.** To use the System, you will need the following accessories in order to assemble the recommended circuit.
- **Respironics Nasal Mask with integrated exhalation port**  
(or Respironics mask with separate exhalation port such as the Whisper Swivel® II)
  - **Respironics 6 ft. (1.83 m) Flexible Tubing**
  - **Respironics Headgear** (for the mask)

**WARNING!** *If the REMstar Auto is used for multiple persons (e.g., rental devices) a low-resistance, main flow bacteria filter should be installed in-line between the REMstar Auto and the circuit tubing. Pressures must be verified when alternate or optional accessories are in place.*

- a. **Connect the flexible tubing to the air outlet on the front of the REMstar Auto.**

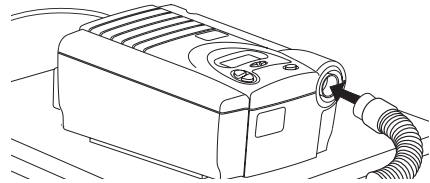

- b. **If you are using a mask with a built-in exhalation port** connect the mask's connector to the flexible tubing.

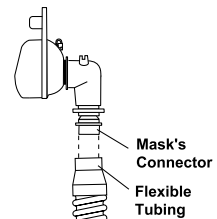

- If you are using a mask with a separate exhalation port** connect the flexible tubing to the exhalation port. Position the exhalation port so that the vented air is blowing away from your face. Connect the mask's connector to the exhalation port.

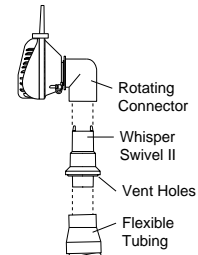

**WARNING!** *Do not block or otherwise try to seal the air openings on the exhalation port. Explanation of the warning: The REMstar Auto is intended to be used with masks and circuits that have an exhalation port designed to exhaust CO<sub>2</sub> from the circuit. When the REMstar Auto is turned on and functioning properly, new air from the REMstar Auto flushes the exhaled air out through the exhalation port. When the REMstar Auto is turned off, enough fresh air will not be provided through the mask, and exhaled air may be rebreathed. Rebreathing of exhaled air for longer than several minutes can, in some circumstances, lead to suffocation. This warning applies to most CPAP devices.*

**WARNING!** *If you are using a full face mask (i.e., a mask covering both your mouth and your nose), the mask must be equipped with a safety (entrainment) valve.*

# Accessories

*Contact your home care provider for additional information on the accessories available for the REMstar Auto System. When using optional accessories, always follow the instructions enclosed with the accessories.*

## Adding a Humidifier

The REMstar Heated Humidifier is available from your home care provider. A humidifier may reduce nasal dryness and irritation by adding moisture (and heat if applicable) to the airflow.

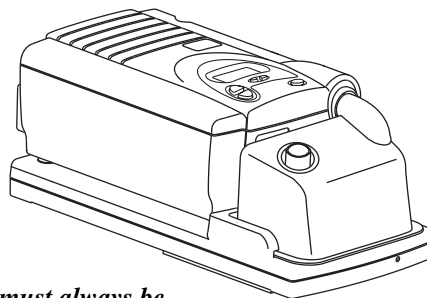

### **WARNING!**

*For safe operation, the humidifier must always be positioned below the circuit connection at the mask and the air outlet on the device. The humidifier must be level for proper operation.*

## Adding Oxygen

Oxygen may be added at the mask connection. Please note the warnings listed below when using oxygen with the REMstar Auto.

### **WARNING!**

*When using oxygen with the REMstar Auto, the oxygen supply must comply with the local regulations for medical oxygen.*

### **WARNING!**

*When using oxygen with the REMstar Auto, a Respiration Pressure Valve (part number 302418) must be placed in-line with the patient circuit.*

### **WARNING!**

*When using oxygen with the REMstar Auto, turn the REMstar Auto on before turning the oxygen on. Turn the oxygen off before turning the REMstar Auto off.*

*Explanation of Warning: When the REMstar Auto is turned off, but the oxygen flow is still turned on, oxygen may accumulate within the REMstar Auto enclosure and create a fire risk. Turning the oxygen off before turning the REMstar Auto off will prevent oxygen accumulation in the REMstar Auto and will reduce the risk of fire. This warning applies to most CPAP devices.*

### **WARNING!**

*Oxygen accelerates fires. Keep the REMstar Auto and the oxygen container away from heat, open flames, any oily substance, or other sources of ignition. DO NOT smoke in the area near the REMstar Auto or the oxygen container.*

## Using DC Power

You can also use the REMstar Auto in a stationary recreational vehicle, boat, or motor home with a 12 volt DC power source. Do not operate the REMstar Auto while the vehicle is in motion. Contact your home care provider for additional information.

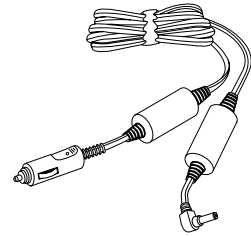

### **CAUTION!**

*Use only the Respironics DC power system available from your home care provider. Use of any other system may cause damage to the REMstar Auto or your vehicle.*

# ***Routine Use***

## **Connecting the Circuit**

### **IMPORTANT!**

#### **1. Connect the circuit.**

*Before each use, examine the flexible tubing for any damage or debris. If necessary, clean the tubing to remove the debris. Replace any damaged tubing.*

- a. Connect the mask to the headgear, following the instructions included with the headgear.
- b. Put on the mask and headgear, and breathe normally through your nose. The airflow should automatically turn ON when you begin breathing through the circuit. If the airflow does not turn on within four breaths, turn it ON by pressing the Pressure On/Off button on the top of the REMstar Auto. When operating the system with some mask types or some circuit configurations, the airflow may NOT automatically turn on.

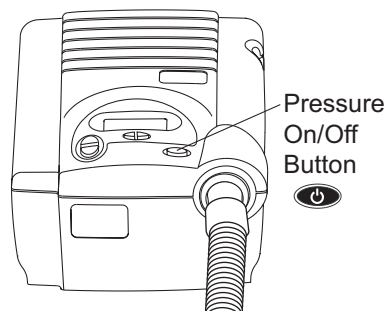

## **Adjusting the Circuit**

2. **Adjust the circuit.** Lie down on your bed, and adjust the flexible tubing so it is free to move if you turn in your sleep. Adjust the mask and headgear until you have a comfortable fit and there are no airflow leaks into your eyes.



## Using the Ramp Button

Pressing the Ramp button will reduce the air pressure when you are trying to fall asleep. The air pressure will gradually increase until your prescription pressure is reached.

- **When the REMstar Auto is in the Auto-CPAP Mode** - Pressing the button will reduce the pressure and then automatically increase the pressure during the night to the appropriate level to meet your needs.
- **When the REMstar Auto is in the CPAP Mode** - If your physician prescribed ramp for you, pressing the button will reduce the pressure and then gradually increase (ramp) the pressure to the therapeutic pressure setting so that you can fall asleep more comfortably.

*Note: The ramp feature is not prescribed for all users.*

## Turning the System OFF

3. Press the Ramp button on the top of the REMstar Auto. You can use the Ramp button as often as you wish during the night.

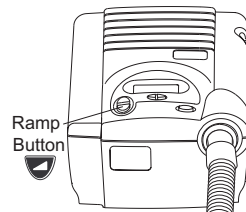

4. Remove the mask and headgear.

If the mask alert has been turned off, after several seconds, the airflow will reduce to a low pressure and then will automatically turn off (in less than 2 minutes after you remove the mask).

If the audible mask alert has been turned on, after several seconds, the airflow will decrease to a low pressure. After approximately 45 seconds the alert tone will sound. Then the airflow will automatically turn off (in less than 2 minutes after you remove the mask).

You can also press the Pressure On /Off button on the top of the REMstar Auto to turn the airflow OFF at any time.

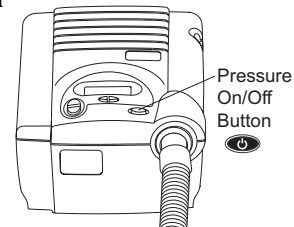

## IMPORTANT!



*The humidifier button is active only when a REMstar Heated Humidifier is connected or when the REMstar Auto is in the Setup Menu. Refer to the REMstar Heated Humidifier's instructions for additional information.*

## Helpful Hints

- If the alert tone sounds, press any button on the REMstar Auto to silence the alert tone. Refer to the "Troubleshooting" section of the manual for further instructions.
- Make sure that bedding, curtains, or other items are not blocking the filter or vents of the REMstar Auto. Air must flow freely around the REMstar Auto for the system to work properly.
- If the airflow from the REMstar Auto feels cold, reposition the circuit tubing so that it runs under your bed covers to reduce heat loss while you sleep.

# *Traveling with the System*

## **Packing the System**

When you are traveling, the carrying case is for carry-on luggage *only*. The carrying case will not protect the system if it is stored as checked baggage.

## **Security Stations**

For convenience at security stations, there is a note on the bottom of the REMstar Auto stating that it is medical equipment. It may be helpful to bring this manual along with you to help security personnel understand the REMstar Auto.

## **Checking the Power Cord**

If you are traveling to a country with a line voltage different than the one you are currently using, a different power cord or an international plug adapter may be required to make your power cord compatible with the power outlets of the country to which you are traveling. Contact your home care provider for additional information.

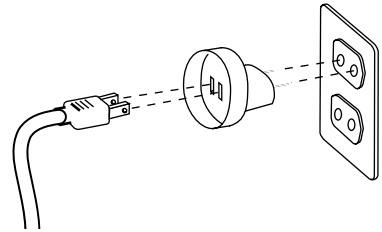

# ***Routine Maintenance***

## **Cleaning the Filter**

The gray pollen filter should be cleaned at least once every two weeks under normal usage and replaced with a new one every six months. The white ultra-fine filter is disposable and should be replaced after 30 nights of use or sooner if it appears dirty. DO NOT clean the ultra-fine filter.

### **CAUTION!**

*Operating the REMstar Auto with a dirty filter may keep the system from working properly and may damage the REMstar Auto.*

- 1. Remove the filter cap by gently pressing on its sides.**
- 2. Change the filter.**
  - a.** Remove the pollen filter by gently pulling around the edges of the filter. Rinse the filter in a steady stream of running water. Squeeze out the water and repeat. Air dry the filter on a rack for 8 to 12 hours or in a clothes dryer for 15 to 20 minutes.  
  
If you are using the white ultra-fine filter and it appears dirty, discard the filter and replace it with a new one.
  - b.** Place the white ultra-fine filter under the clean pollen filter. Insert the filter(s) into the filter area on the back of the REMstar Auto. Replace the filter cap.

### **CAUTION!**

*Never install a wet filter into the REMstar Auto. We recommend that you clean the filter in the morning and alternate using the two filters provided with the system to ensure enough drying time for the cleaned filter.*

## **Cleaning the System**

Clean the mask and tubing daily.

### **WARNING!**

*To avoid electrical shock, unplug the REMstar Auto before cleaning. Do not immerse the REMstar Auto in any fluids.*

- 1. Disconnect the flexible tubing from the REMstar Auto. Gently wash the flexible tubing in a solution of warm water and a mild detergent. Rinse the tubing thoroughly and air dry.**
- 2. Wipe the outside of the REMstar Auto with a cloth slightly dampened with water and a mild detergent. Let the REMstar Auto dry before plugging in the power cord.**
- 3. Inspect the REMstar Auto and all circuit parts for any damage after cleaning. Replace any damaged parts.**
- 4. For details on cleaning your mask and accessories, refer to the cleaning instructions packaged with the accessories.**

# *Service*

## **Reordering**

Contact your home care provider to order accessories or replacement filters.

## **Service**

The REMstar Auto system does not require routine servicing.

When necessary, dispose of the REMstar Auto and accessories in accordance with local regulations.

### **WARNING!**





*If you notice any unexplained changes in the performance of the REMstar Auto, if it is making unusual or harsh sounds, if it has been dropped or mishandled, if the enclosure is broken, or if water has entered the enclosure, discontinue use. Contact your home care provider.*

### **WARNING!**

*If the REMstar Auto malfunctions, contact your home care provider immediately. Never attempt to open the REMstar Auto's enclosure. Repairs and adjustments must be performed by Respironics authorized service personnel only. Unauthorized service could cause injury, invalidate the warranty, or result in costly damage.*

# Troubleshooting

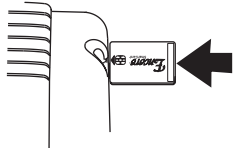
The table below lists common problems you may have with the REMstar Auto system and possible solutions to those problems. If none of the corrective actions solve the problem, contact your home care provider.

Problem	Solution(s)
<p>The “Attention” symbol and the “Patient Disconnect” symbol are flashing on the display screen and the alert tone is sounding.</p> 	<p>Press any button on the REMstar Auto to silence the alert tone and stop the flashing. The system has detected a large leak in the circuit or you have taken the mask off without turning the airflow off. Check the circuit connections for leaks.</p>
<p>The “Attention” symbol, the “SmartCard” symbol, and an error code (C-???) are flashing on the display screen and the alert tone is sounding.</p> 	<p>The SmartCard is installed incorrectly or is damaged. Remove the SmartCard and verify that it was installed as shown. Reinsert the SmartCard. If the alert tone sounds again, remove the SmartCard, and contact your home care provider or Respironics for directions on having the SmartCard replaced. Please have the error code ready when you call.</p> 
<p>The “Attention” symbol and an error code (E-???) are flashing on the display screen, the alert tone is sounding, and the buttons are flashing.</p> 	<p>Press any button on the REMstar Auto to silence the alert tone. Discontinue use. Disconnect the power cord from the AC wall outlet. Contact your home care provider or Respironics for directions on having the REMstar Auto serviced. Please have the device’s serial number and the error code ready when you call.</p>
<p>The pressure being delivered feels different.</p>	<p>Contact your home care provider or Respironics for directions on having the REMstar Auto serviced. Please have the device’s serial number ready when you call.</p>

# Troubleshooting

<b>Problem</b>	<b>Solution(s)</b>
The airflow from the REMstar Auto seems warm.	Replace or clean the filter. Make sure the REMstar Auto is away from bedding or curtains that could block the flow of air around the REMstar Auto. Make sure the REMstar Auto is away from heating equipment (e.g., forced air vents, radiators).
The noise level of the REMstar Auto has changed to include unusual or harsh sounds during operation.	Contact your home care provider or Respironics for directions on having the REMstar Auto serviced. Please have the device's serial number ready when you call.
The REMstar Auto will not turn on.	Make sure that the REMstar Auto is plugged into a working outlet. If you are using DC power accessories with a battery, the battery may need to be recharged or replaced or the DC Cord's fuse may need to be replaced. Contact your home care provider or Respironics for directions on having the REMstar Auto serviced. Please have the device's serial number ready when you call.
Pressing the Ramp button does not reduce the air pressure.	Contact your home care provider. Ramp may not have been prescribed for you.
The REMstar Auto has been dropped into water or fluids have gotten into the enclosure.	Discontinue use. Disconnect the power cord from the AC wall outlet. Contact your home care provider or Respironics for directions on having the REMstar Auto serviced. Please have the device's serial number ready when you call.

## ***Limited Warranty***

Respironics, Inc.<sup>®</sup> warrants that the REMstar<sup>®</sup> Auto CPAP device shall be free from defects of workmanship and materials and will perform in accordance with the product specifications for a period of two (2) years from the date of sale by Respironics, Inc. to the dealer. If the product fails to perform in accordance with the product specifications, Respironics, Inc. will repair or replace, at its option, the defective material or part. Respironics, Inc. will pay customary freight charges from Respironics, Inc. to the dealer location only. This warranty does not cover damage caused by accident, misuse, abuse, alteration and other defects not related to material or workmanship.

RESPIRONICS, INC. DISCLAIMS ALL LIABILITY FOR ECONOMIC LOSS, LOSS OF PROFITS, OVERHEAD OR CONSEQUENTIAL DAMAGES WHICH MAY BE CLAIMED TO ARISE FROM ANY SALE OR USE OF THIS PRODUCT. SOME STATES DO NOT ALLOW THE EXCLUSION OR LIMITATION OF INCIDENTAL OR CONSEQUENTIAL DAMAGES, SO THE ABOVE LIMITATION OR EXCLUSION MAY NOT APPLY TO YOU.

THIS WARRANTY IS GIVEN IN LIEU OF ALL OTHER EXPRESS WARRANTIES. IN ADDITION, ANY IMPLIED WARRANTIES, INCLUDING ANY WARRANTY OF MERCHANTABILITY OR FITNESS FOR THE PARTICULAR PURPOSE ARE LIMITED TO TWO YEARS. SOME STATES DO NOT ALLOW LIMITATIONS ON HOW LONG AN IMPLIED WARRANTY LASTS, SO THE ABOVE LIMITATION MAY NOT APPLY TO YOU. THIS WARRANTY GIVES YOU SPECIFIC LEGAL RIGHTS, AND YOU MAY ALSO HAVE OTHER RIGHTS WHICH VARY FROM STATE TO STATE.

To exercise your rights under this warranty, contact your local, authorized Respironics, Inc. dealer or Respironics, Inc. at 1001 Murry Ridge Lane, Murrysville, Pennsylvania 15668, 1-800-345-6443 (US and Canada only) or 1-724-387-4000.

**For information on sleep disorders, contact the following organizations:**

**American Sleep Apnea Association  
2025 Pennsylvania Ave., N.W., Suite 905  
Washington, DC 20006  
Telephone: 1-202-293-3650  
Fax: 1-202-293-3656  
[www.sleepapnea.org](http://www.sleepapnea.org)**

**National Sleep Foundation  
729 Fifteenth Street, N.W., Fourth Floor  
Washington, DC 20005  
[www.sleepfoundation.org](http://www.sleepfoundation.org)**



**IMPORTANT!**

**Fill in the information below when you receive the REMstar Auto CPAP system.**

REMstar Auto Serial No.: \_\_\_\_\_ (Located on the bottom of the REMstar Auto)

System Prescribed for: \_\_\_\_\_

Date of Purchase or Rental: \_\_\_\_\_

Mode of Therapy: \_\_\_ Auto CPAP \_\_\_ CPAP Pressure Setting: \_\_\_ cm H<sub>2</sub>O

Mask Type: \_\_\_\_\_

Mask Size: \_\_\_\_\_

**If you have any questions concerning the system, contact:**

• Home Care Company: \_\_\_\_\_

Telephone Number: \_\_\_\_\_

• Health Care Professional: \_\_\_\_\_

Telephone Number: \_\_\_\_\_

• Respironics, Inc.

1001 Murry Ridge Lane

Murrysville, Pennsylvania

15668-8550 USA

Customer Service

Telephone Number: 1-800-345-6443 (US and Canada) or 1-724-387-4000

REMstar Auto CPAP systems are the subject of US patent #5,239,995. Other patents pending.

REMstar Auto and Whisper Swivel are trademarks of Respironics, Inc.

© Respironics, Inc. 2001