







Table of Contents



Symbol Key	2
Intended Use & Contraindications	3
Specifications	4
Warnings & Cautions	5
System Features	7
First Time Setup	8
○ Installing the Filter	9
○ Assembling the Circuit	10
Accessories	11
○ Adding a Humidifier	11
○ Adding Oxygen to the System	11
○ Using a Carrying Case	11
Routine Use	12
○ Connecting the Circuit	12
○ Adjusting the Circuit	12
○ Ramp Button	13
○ Turning the System Off	13
○ Helpful Hints	13
Traveling with the System / Elevation Setting	14
Routine Maintenance	16
○ Cleaning the Filter	16
○ Cleaning the System	16
○ Reordering	17
○ Service	17
Troubleshooting	18
Warranty	19

Symbols







Display Screen

-  Attention is needed
-  Centimeters of water (displayed with pressure readings or settings)
-  Blower Operation Time
-  Blower Hour Meter
-  Number of nights with more than 4 hours usage
-  Elevation

Control Buttons

-  Pressure Start / Stop
-  Ramp Start

REMstar Lite Device

-  Attention, Consult Accompanying Documents
-  AC Power
-  Type BF Applied Part
-  Class II (Double Insulated)
- IPX0** Ordinary Equipment Rating
-  European CE Declaration of Conformity
-  Notified Body Approval for Standards Compliance
-  Canadian/US Certification

Intended Use

The Respironics REMstar Lite System is a CPAP (Continuous Positive Airway Pressure) device designed for the treatment of adult Obstructive Sleep Apnea (OSA) only.

The REMstar Lite is to be used only on the instruction of a licensed health care professional. Your home care provider will make the correct pressure settings according to your health care professional's prescription.

Several accessories are available to make your OSA treatment with the REMstar Lite CPAP System as convenient and comfortable as possible. To ensure that you receive the safe, effective therapy prescribed for you, use only Respironics accessories.

IMPORTANT! *Read and understand the entire user's manual before operating this system. If you have any questions concerning the use of this system, contact your home care provider or health care professional.*

Contraindications

Studies have shown that the following pre-existing conditions may contraindicate the use of positive airway pressure therapy for some patients:

- Bullous Lung Disease
- Bypassed Upper Airway
- Pneumothorax
- Pathologically Low Blood Pressure
- Pneumocephalus has been reported in a patient using nasal Continuous Positive Airway Pressure. Caution should be used when prescribing CPAP for susceptible patients such as those with: cerebral spinal fluid (CSF) leaks, abnormalities of the cribriform plate, prior history of head trauma, and/or pneumocephalus. (Chest 1989; 96:1425-1426)

The use of positive airway pressure therapy may be temporarily contraindicated if you exhibit signs of a sinus or middle ear infection. Contact your health care professional if you have any questions concerning your therapy.

Specifications

Device Size	Dimensions: 9 1/2" x 6 7/8" x 4 1/2" (24 x 17 x 12 cm) Weight: <4.0 lbs. (<1.8 kg)												
Product Use, Transport, and Storage	<table><thead><tr><th></th><th>Operation</th><th>Transport & Storage</th></tr></thead><tbody><tr><td>Temperature:</td><td>41 to 95° F (5 to 35° C)</td><td>-4 to 140° F (-20 to 60° C)</td></tr><tr><td>Humidity:</td><td>15 to 95% Non-condensing</td><td>15 to 95% Non-condensing</td></tr><tr><td>Atmospheric Pressure:</td><td>76.7 to 102 kPascals</td><td>N/A</td></tr></tbody></table>		Operation	Transport & Storage	Temperature:	41 to 95° F (5 to 35° C)	-4 to 140° F (-20 to 60° C)	Humidity:	15 to 95% Non-condensing	15 to 95% Non-condensing	Atmospheric Pressure:	76.7 to 102 kPascals	N/A
	Operation	Transport & Storage											
Temperature:	41 to 95° F (5 to 35° C)	-4 to 140° F (-20 to 60° C)											
Humidity:	15 to 95% Non-condensing	15 to 95% Non-condensing											
Atmospheric Pressure:	76.7 to 102 kPascals	N/A											
Standards Compliance	This device is designed to conform to the following standards: IEC 60601-1 General Requirements for Safety of Medical Electrical Equipment prEN ISO 17510-1 Sleep Apnea Breathing Therapy Devices												
Mode of Operation	Continuous												
Power Requirements	AC Power Consumption: 100 - 240 VAC, 50/60 Hz, 1.0 A max.												
Type of Protection Against Electric Shock	Class II Equipment												
Degree of Protection Against Electric Shock	Type BF Applied Part												
Degree of Protection Against Ingress of Water	IPX0 - Ordinary Equipment												
Pressure Increments	4 to 20 cm H ₂ O (in 1.0 cm H ₂ O increments)												
Pressure Stability	4 to 20 cm H ₂ O (±1.0 cm H ₂ O) Measured in accordance with prEN 17510 @ 7, 13, & 20 cm H ₂ O @ 500 ml with BPM set to 10, 15, & 20 BPM performed at 23° C (±2° C), 50% RH (±5%), and an atmospheric pressure of 101.54 kPascals.												
Sound Pressure Level	<30 dB(A) Measured in accordance with prEN 17510 @ 10 cm H ₂ O at the patient circuit. This measurement applies to the CPAP device with or without the optional REMstar Heated Humidifier.												
Maximum Flow	35 LPM Measured in accordance with prEN 17510 @ 7, 13, & 20 cm H ₂ O @ 500 ml with BPM set to 10, 15, & 20 BPM performed at 23° C (±2° C), 50% RH (±5%), and an atmospheric pressure of 101.54 kPascals.												

Warnings & Cautions

CAUTION!

- *US federal law restricts this device to sale by or on the order of a physician.*

WARNING!

Indicates the possibility for injury to the user or the operator.

- *The instructions in this manual are not intended to supersede established medical protocols.*
- *This device is intended for adult use only.*
- *This device is not intended for life support.*
- *CPAP devices have the potential to allow rebreathing of exhaled air. To reduce this potential, observe the following:*
 - *Use Respironics circuit accessories.*
 - *Do not wear the mask and headgear for more than a few minutes while the device is not operating.*
 - *Do not block or try to seal the vent holes in the exhalation port.*

As with most CPAP devices: At low CPAP pressures, some exhaled gas (CO₂) may remain in the mask and be rebreathed.

- *Do not use this device if the room temperature is warmer than 95° F (35° C). If this device is used at room temperatures warmer than 95° F (35° C), the temperature of the airflow may exceed 106° F (41° C). This could cause irritation to your airway.*
- *This equipment is not suitable for use in the presence of a flammable anaesthetic mixture in combination with oxygen or air, or in the presence of nitrous oxide.*
- *If you notice any unexplained changes in the performance of the REMstar Lite, if it is making unusual or harsh sounds, if it has been dropped or mishandled, if the enclosure is broken, or if water has entered the enclosure, disconnect the power cord and discontinue use. Contact your home care provider.*
- *To avoid electrical shock, disconnect the power cord before cleaning. DO NOT immerse the device in any fluids.*
- *Contact your health care professional if symptoms of sleep apnea recur.*
- *Using the REMstar Lite at an incorrect elevation setting could result in airflow pressures higher than the prescribed setting. Always verify the elevation setting when traveling or relocating.*

CAUTION!

Indicates the possibility of damage to the device.

- *Tobacco smoke may cause tar build-up within the REMstar Lite that may result in the REMstar Lite malfunctioning.*

Additional warnings and cautions are located throughout this manual as they apply.

Unpacking the System

After unpacking the system, make sure you have everything shown here:

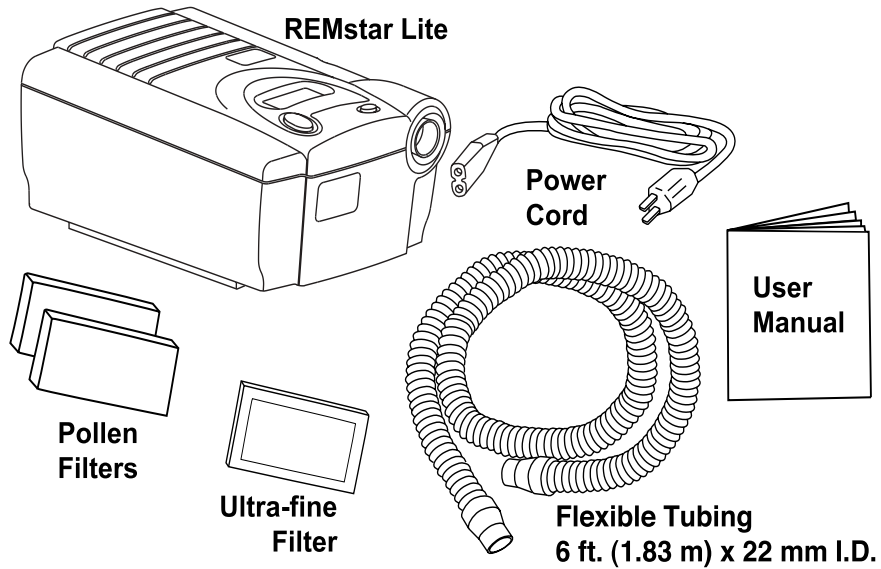

IMPORTANT! *If any of the above parts are missing, contact your home care provider.*

System Features

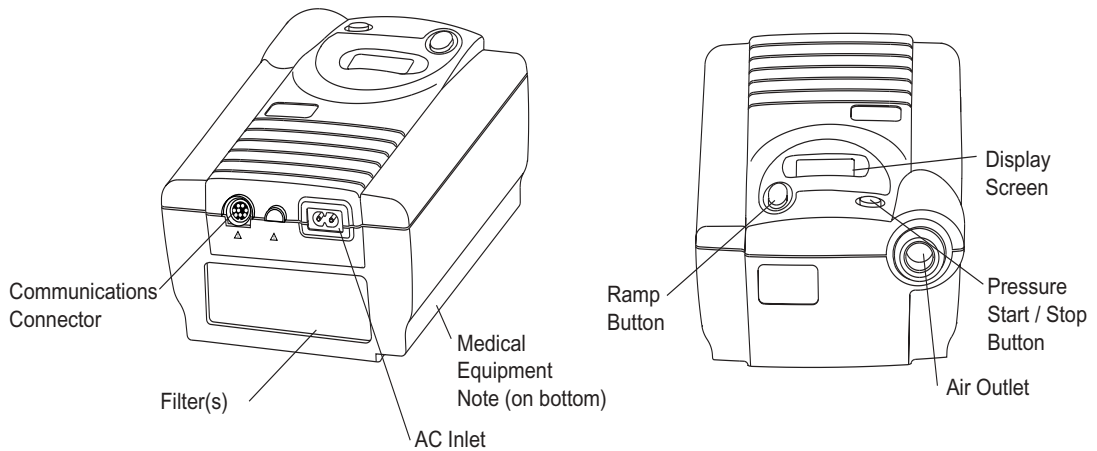

AC Inlet Connect / disconnect the AC power cord here.

Air Outlet Connect the flexible tubing here.

Display Screen Blower operation time and Blower time meter will appear here. Displays the pressure setting.

Communications Connector For clinical use with the Encore® Pro Data Management Software or an IEC 950 approved device. Connect the communications cable here.

Filters The pollen filter screens out normal household dust and pollens. The optional, ultra-fine filter is also included for more complete filtration of very fine particles.

Medical Product Note For ease at airport security stations, there is a note on the bottom of the REMstar Lite stating that it is medical equipment. It may help if you also take this manual with you when you travel.

Pressure Start / Stop Button This button starts / stops the airflow.

Ramp Button This button starts the ramp cycle or allows access the REMstar Lite settings.

First Time Setup

WARNING!

Do not use the REMstar Lite System until an appropriate professional adjusts the settings! To order any accessories not included with this system, contact your home care provider.

Note to home care provider: Before beginning setup, be sure that you have available the REMstar Lite Home Care Provider Setup Instructions. Setup instructions are not provided in this manual.

WARNING!

***DO NOT** connect any equipment to the REMstar Lite unless recommended by Respironics or your health care professional.*

WARNING!

Respironics circuit accessories (e.g., nasal mask, exhalation port, tubing) are for single patient use only and are not intended to be used on multiple patients.

CAUTION!

If the REMstar Lite has been exposed to either very hot or very cold temperatures, allow it to adjust to room temperature (approximately 2 hours) before beginning setup.

CAUTION!

Your home care provider will have installed the filter(s). The pollen filter must be in place at all times when the REMstar Lite is operating. The white ultra-fine filter is optional and can be used in addition to the pollen filter. The ultra-fine filter is recommended for people who are sensitive to tobacco smoke or other small particles.

First Time Setup

Power Cord

1. **Connect the power cord.** Plug the socket end of the power cord into the AC inlet on the back of the REMstar Lite. Plug the pronged end of the power cord into an electrical outlet.

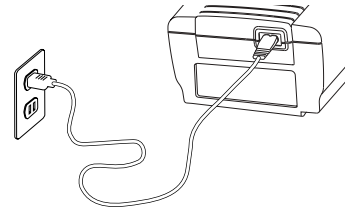

IMPORTANT! *To remove AC power, disconnect the power cord from the electrical outlet.*

WARNING! *Inspect the power cord often for any signs of damage. Replace a damaged cord immediately.*

WARNING! *The REMstar Lite is activated and ready for use when the power cord is connected. The pressure start / stop button turns the airflow on / off.*

CAUTION! *2. Place the REMstar Lite on a firm, flat surface.*

Make sure the REMstar Lite is away from any heating or cooling equipment (e.g., forced air vents, radiators, air conditioners). Also make sure that bedding, curtains, or other items are not blocking the filter or vents of the device. Air must flow freely around the device for the system to work properly.

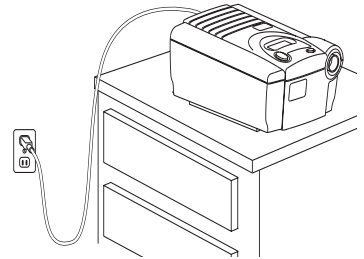

First Time Setup

Assembling the Circuit

3. **Assemble the circuit.** To use the system, you will need the following accessories in order to assemble the recommended circuit.

- **Respironics nasal mask with integrated exhalation port**
(or Respironics mask with separate exhalation port such as the Whisper Swivel® II)
- **Respironics 6 ft. (1.83 m) flexible tubing**
- **Respironics headgear** (for the mask)

WARNING!

If the REMstar Lite is used for multiple persons (e.g., rental devices) a low-resistance, main flow bacteria filter should be installed in-line between the REMstar Lite and the circuit tubing. Pressures must be verified when alternate or optional accessories are in place.

- a. **Connect the flexible tubing to the air outlet on the front of the REMstar Lite.**

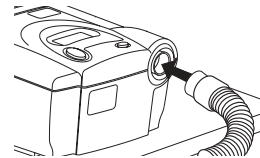

- b. **If you are using a mask with a built-in exhalation port connect the mask's connector to the flexible tubing.**

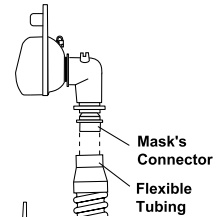

If you are using a mask with a separate exhalation port connect the flexible tubing to the exhalation port. Position the exhalation port so that the vented air is blowing away from your face. Connect the mask's connector to the exhalation port.

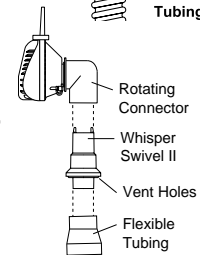

WARNING!

Do not block or otherwise try to seal the air openings on the exhalation port.

Explanation of the warning: The REMstar Lite is intended to be used with masks and circuits that have an exhalation port designed to exhaust CO₂ from the circuit. When the REMstar Lite is turned on and functioning properly, new air from the REMstar Lite flushes the exhaled air out through the exhalation port. When the REMstar Lite is turned off, enough fresh air will not be provided through the mask, and exhaled air may be rebreathed. Rebreathing of exhaled air for longer than several minutes can, in some circumstances, lead to suffocation. This warning applies to most CPAP devices.

WARNING!

If you are using a full face mask (i.e., a mask covering both your mouth and your nose), the mask must be equipped with a safety (entrainment) valve.

Accessories

IMPORTANT! *Contact your home care provider for additional information on the accessories available for the REMstar Lite system. When using optional accessories, always follow the instructions enclosed with the accessories.*

Adding a Humidifier

The Respironics H2 Heated Humidifier and REMstar Pass-over Humidifier are available from your home care provider. A humidifier may reduce nasal dryness and irritation by adding moisture (and heat if applicable) to the airflow.

WARNING! *For safe operation, the humidifier must always be positioned below the circuit connection at the mask and the air outlet on the device. The humidifier must be level for proper operation.*

Adding Oxygen

Oxygen may be added at the mask connection. Please note the warnings listed below when using oxygen with the REMstar Lite.

WARNING! *When using oxygen with the REMstar Lite, the oxygen supply must comply with the local regulations for medical oxygen.*

WARNING! *When using oxygen with the REMstar Lite, a Respironics Pressure Valve (part number 302418) must be placed in-line with the patient circuit.*

WARNING! *When using oxygen with the REMstar Lite, turn the REMstar Lite on before turning the oxygen on. Turn the oxygen off before turning the REMstar Lite off. Explanation of Warning: When the REMstar Lite is turned off, but the oxygen flow is still turned on, oxygen may accumulate within the REMstar Lite enclosure and create a fire risk. Turning the oxygen off before turning the REMstar Lite off will prevent oxygen accumulation in the REMstar Lite and will reduce the risk of fire. This warning applies to most CPAP devices.*

WARNING! *Oxygen accelerates fires. Keep the REMstar Lite and the oxygen container away from heat, open flames, any oily substance, or other sources of ignition. DO NOT smoke in the area near the REMstar Lite or the oxygen container.*

Carrying Case

A carrying case that holds the REMstar Lite and accessories is available from Respironics. When traveling by airplane, the carrying case is for carry-on luggage *only*. Never check the REMstar Lite through the baggage department.

Routine Use

Connecting the Circuit

IMPORTANT!

Before each use, examine the flexible tubing for any damage or debris. If necessary, clean the tubing to remove the debris. Replace any damaged tubing.

1. Connect the circuit.

- a. Connect the mask to the headgear, following the instructions included with the headgear.
- b. Put on the mask and headgear. Press the Pressure Start / Stop button on the top of the REMstar Lite to turn the airflow ON. Breathe normally through your nose.

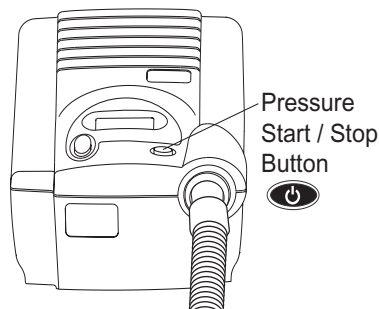

Adjusting the Circuit

2. **Adjust the circuit.** Lie down on your bed, and adjust the flexible tubing so it is free to move if you turn in your sleep. Adjust the mask and headgear until you have a comfortable fit and there are no airflow leaks into your eyes.

Using the Ramp Button

Pressing the ramp button will reduce the air pressure when you are trying to fall asleep and then gradually increase (ramp) the pressure until your prescription pressure is reached **so that you can fall asleep more comfortably**. *Note: The ramp feature is not prescribed for all users.*

3. **Press the ramp button on the top of the REMstar Lite.** You can use the ramp button as often as you wish during the night.

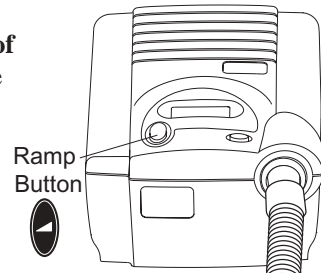

Turning the System OFF

4. **Remove the mask and headgear.**

Press the pressure start / stop button on the top of the REMstar Lite to turn the airflow OFF at any time.

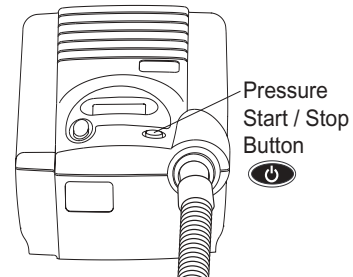

Helpful Hints

- Make sure that bedding, curtains, or other items are not blocking the filter or vents of the REMstar Lite. Air must flow freely around the REMstar Lite for the system to work properly.
- If the airflow from the REMstar Lite feels cold, reposition the circuit tubing so that it runs under your bed covers to reduce heat loss while you sleep.

Traveling with the System / Elevation Setting

Elevation Setting

WARNING!

Always verify the elevation setting when traveling or relocating. Using the REMstar Lite at an incorrect elevation setting could result in incorrect airflow pressures.

IMPORTANT!

When changing the elevation setting, the airflow must be turned OFF.

The ramp button operates as an up and down key to change the settings (up = increase; down = decrease). The pressure start / stop button allows you to go to the next screen.



Next / Exit
Settings



1. Hold the top or bottom of the ramp button down until the elevation setting and symbol appears.



- 1 = less than 2,500 ft. (< 762 m)
- 2 = 2,500 to 5,000 ft. (762 m to 1524 m)
- 3 = 5,001 to 7,500 ft. (1525 m to 2286 m)

To change the elevation setting, press the top or bottom of the ramp button until the correct setting appears.

Press the pressure start / stop button to go to the next screen.

2. The number of nights the REMstar Lite was used for more than four consecutive hours will appear. Your home care provider may ask you to record this total occasionally.



Press the pressure start / stop button to go back to the main screen.

Traveling with the System

Packing the System

When you are traveling, the optional carrying case is for carry-on luggage *only*. The carrying case will not protect the system if it is stored as checked baggage.

Security Stations

For convenience at security stations in airports, train terminals, etc., there is a note on the bottom of the REMstar Lite stating that it is medical equipment. It may be helpful to bring this manual along with you to help security personnel understand the REMstar Lite.

Checking the Power Cord

If you are traveling to a country with a line voltage different than the one you are currently using, a different power cord or an international plug adapter may be required to make your power cord compatible with the power outlets of the country to which you are traveling. Contact your home care provider for additional information.

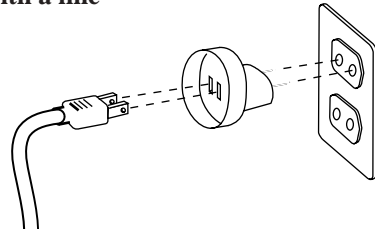

Routine Maintenance

Cleaning the Filter

The gray pollen filter should be cleaned at least once every two weeks under normal usage and replaced with a new one every six months. The white ultra-fine filter is disposable and should be replaced after 30 nights of use or sooner if it appears dirty. DO NOT clean the ultra-fine filter.

CAUTION!

Operating the REMstar Lite with a dirty filter may keep the system from working properly and may damage the REMstar Lite.

1. Remove the pollen filter by gently pulling around the edges of the filter. Rinse the filter in a steady stream of running water. Squeeze out the water and repeat. Air dry the filter on a rack for 8 to 12 hours or in a clothes dryer for 15 to 20 minutes.

If you are using the white ultra-fine filter and it appears dirty, discard the filter and replace it with a new one.

2. Place the white ultra-fine filter under the clean pollen filter. Insert the filter(s) into the filter area on the back of the REMstar Lite.

CAUTION!

Never install a wet filter into the REMstar Lite. We recommend that you clean the filter in the morning and alternate using the two filters provided with the system to ensure enough drying time for the cleaned filter.

Cleaning the System

Clean the mask and tubing daily.

WARNING!

To avoid electrical shock, unplug the REMstar Lite before cleaning. Do not immerse the REMstar Lite in any fluids.

1. Disconnect the flexible tubing from the REMstar Lite. Gently wash the flexible tubing in a solution of warm water and a mild detergent. Rinse the tubing thoroughly and air dry.
2. Wipe the outside of the REMstar Lite with a cloth slightly dampened with water and a mild detergent. Let the REMstar Lite dry before plugging in the power cord.
3. Inspect the REMstar Lite and all circuit parts for any damage after cleaning. Replace any damaged parts.
4. For details on cleaning your mask and accessories, refer to the cleaning instructions packaged with the accessories.

Reordering

Contact your home care provider to order accessories or replacement filters.

Service

The REMstar Lite system does not require routine servicing.

When necessary, dispose of the REMstar Lite and accessories in accordance with local regulations.

WARNING!

If you notice any unexplained changes in the performance of the REMstar Lite, if it is making unusual or harsh sounds, if it has been dropped or mishandled, if the enclosure is broken, or if water has entered the enclosure, discontinue use. Contact your home care provider.

WARNING!

If the REMstar Lite malfunctions, contact your home care provider immediately. Never attempt to open the REMstar Lite's enclosure. Repairs and adjustments must be performed by Respironics authorized service personnel only. Unauthorized service could cause injury, invalidate the warranty, or result in costly damage.

Troubleshooting

The table below lists common problems you may have with the REMstar Lite system and possible solutions to those problems. If none of the corrective actions solve the problem, contact your home care provider.

Problem	Solution(s)
<p>The “Attention” symbol and an error code (E-???) are flashing on the display screen and the buttons are flashing.</p> 	<p>Discontinue use. Disconnect the power cord from the AC wall outlet. Contact your home care provider or Respironics for directions on having the REMstar Lite serviced. Please have the device’s serial number and the error code ready when you call.</p>
<p>The pressure being delivered feels different.</p>	<p>Verify the elevation setting. Using the REMstar Lite at an incorrect elevation setting could result in airflow pressures higher than the prescribed setting. Contact your home care provider or Respironics for directions on having the REMstar Lite serviced. Please have the device’s serial number ready when you call.</p>
<p>The airflow from the REMstar Lite seems warm.</p>	<p>Replace or clean the filter. Make sure the REMstar Lite is away from bedding or curtains that could block the flow of air around the REMstar Lite. Make sure the REMstar Lite is away from heating equipment (e.g., forced air vents, radiators).</p>
<p>The noise level of the REMstar Lite has changed to include unusual or harsh sounds during operation.</p>	<p>Contact your home care provider or Respironics for directions on having the REMstar Lite serviced. Please have the device’s serial number ready when you call.</p>
<p>The REMstar Lite will not turn on.</p>	<p>Make sure that the REMstar Lite is plugged into a working outlet. Contact your home care provider or Respironics for directions on having the REMstar Lite serviced. Please have the device’s serial number ready when you call.</p>
<p>Pressing the ramp button does not reduce the air pressure.</p>	<p>Contact your home care provider. Ramp may not have been prescribed for you.</p>
<p>The REMstar Lite has been dropped into water or fluids have gotten into the enclosure.</p>	<p>Discontinue use. Disconnect the power cord from the AC wall outlet. Contact your home care provider or Respironics for directions on having the REMstar Lite serviced. Please have the device’s serial number ready when you call.</p>

Limited Warranty

Respironics, Inc.[®] warrants that the REMstar[®] Lite CPAP device shall be free from defects of workmanship and materials and will perform in accordance with the product specifications for a period of two (2) years from the date of sale by Respironics, Inc. to the dealer. If the product fails to perform in accordance with the product specifications, Respironics, Inc. will repair or replace, at its option, the defective material or part. Respironics, Inc. will pay customary freight charges from Respironics, Inc. to the dealer location only. This warranty does not cover damage caused by accident, misuse, abuse, alteration and other defects not related to material or workmanship.

RESPIRONICS, INC. DISCLAIMS ALL LIABILITY FOR ECONOMIC LOSS, LOSS OF PROFITS, OVERHEAD OR CONSEQUENTIAL DAMAGES WHICH MAY BE CLAIMED TO ARISE FROM ANY SALE OR USE OF THIS PRODUCT. SOME STATES DO NOT ALLOW THE EXCLUSION OR LIMITATION OF INCIDENTAL OR CONSEQUENTIAL DAMAGES, SO THE ABOVE LIMITATION OR EXCLUSION MAY NOT APPLY TO YOU.

THIS WARRANTY IS GIVEN IN LIEU OF ALL OTHER EXPRESS WARRANTIES. IN ADDITION, ANY IMPLIED WARRANTIES, INCLUDING ANY WARRANTY OF MERCHANTABILITY OR FITNESS FOR THE PARTICULAR PURPOSE ARE LIMITED TO TWO YEARS. SOME STATES DO NOT ALLOW LIMITATIONS ON HOW LONG AN IMPLIED WARRANTY LASTS, SO THE ABOVE LIMITATION MAY NOT APPLY TO YOU. THIS WARRANTY GIVES YOU SPECIFIC LEGAL RIGHTS, AND YOU MAY ALSO HAVE OTHER RIGHTS WHICH VARY FROM STATE TO STATE.

To exercise your rights under this warranty, contact your local, authorized Respironics, Inc. dealer or Respironics, Inc. at 1001 Murry Ridge Lane, Murrysville, Pennsylvania 15668, 1-800-345-6443 (US and Canada only) or 1-724-387-4000.

For information on sleep disorders, contact the following organizations:

**American Sleep Apnea Association
2025 Pennsylvania Ave., N.W., Suite 905
Washington, DC 20006
Telephone: 1-202-293-3650
Fax: 1-202-293-3656
www.sleepapnea.org**

**National Sleep Foundation
729 Fifteenth Street, N.W., Fourth Floor
Washington, DC 20005
www.sleepfoundation.org**

IMPORTANT!

Fill in the information below when you receive the REMstar Lite CPAP system.

REMstar Lite Serial No.: _____ (Located on the bottom of the REMstar Lite)

System Prescribed for: _____

Date of Purchase or Rental: _____

Pressure Setting: _____ cm H₂O

Mask Type: _____

Mask Size: _____

If you have any questions concerning the system, contact:

• Home Care Company: _____

Telephone Number: _____

• Health Care Professional: _____

Telephone Number: _____

• Respironics, Inc.

1001 Murry Ridge Lane
Murrysville, Pennsylvania
15668-8550 USA

Customer Service Telephone Number:

1-800-345-6443 (US and Canada) or 1-724-387-4000

REMstar Lite CPAP systems are the subject of US patent #5239995. Other patents pending.
REMstar Lite and Whisper Swivel are trademarks of Respironics, Inc.