

Solo™
CPAP System

Solo Plus™
CPAP System

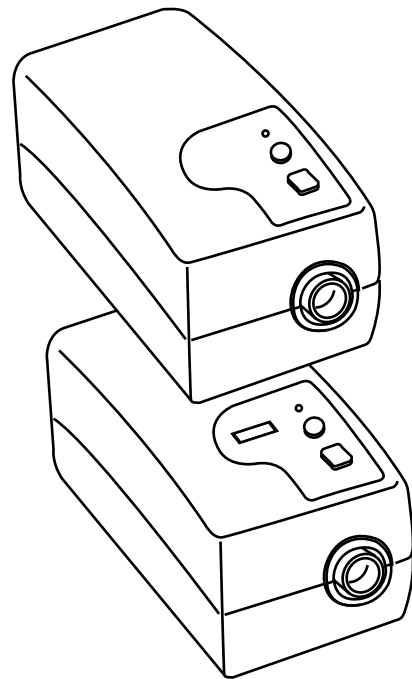

User Instructions

RESPIRONICS INC.®

TABLE OF CONTENTS

Introduction & Contraindications	3
Specifications	4
Warnings & Cautions	5
Unpacking the System	6
System Features	7
First Time Setup	9
Checking the Voltage	10
Installing the Filters	10
Power Cord	11
Assembling the Circuit	12
Accessories	14
Humidifier	14
DC Power System	14
Carrying Case	14
Adding Oxygen to the System	15
Routine Use	16
Connecting the Circuit	16
Adjusting the Circuit	16
Ramp Button	17
Turning the System Off	17
Helpful Hints	17
Traveling with the System	18
Routine Maintenance	20
Filters	20
Fuses	21
Cleaning	22
Reordering	22
Service	23
Troubleshooting	24
Warranty	26
Summary	27

A warranty/comment card should be included with this manual for your completion. If it is not, contact Respiroics' Warranty Administrator at 1-800-666-2901 or 1-412-731-2100 to register your equipment and receive a FREE package of ultra-fine filters.

The Solo and Solo Plus CPAP devices carry a two-year warranty. See the "Warranty" section of this manual for details. You can extend this warranty period to three years for \$39.95. See the warranty/comment card for details or call Respiroics' Warranty Administrator.

For Information on Sleep Disorders Contact:

**American Sleep Apnea Association
2025 Pennsylvania Ave. N.W., Suite 905
Washington D.C. 20006
Telephone: 1-202-293-3650**

**National Sleep Foundation
1367 Connecticut Ave. N.W., Suite 200
Washington D.C. 20036
Telephone: 1-202-785-2300**

Solo™ and Solo™ Plus CPAP Systems are the subject of U.S. patent #5,239,995. Other patents pending.
Solo is a trademark of Respiroics, Inc.

© Respiroics, Inc. 1997

Intended Use

The Solo™ and Solo™ Plus CPAP Systems are part of the Respiroics Great Performers™ series of products for the treatment of adult Obstructive Sleep Apnea (OSA) only. The Solo delivers CPAP (Continuous Positive Airway Pressure) therapy. Your home care provider will make the correct pressure settings.

When prescribed by your physician, the ramp function allows you to lower the pressure when you are trying to fall asleep. The air pressure will gradually increase until your prescription pressure is reached. You also have the option of not using the ramp feature at all.

Several accessories are available to make your OSA treatment with the Solo CPAP System as convenient and comfortable as possible and to ensure that you receive the safe, effective therapy prescribed for you.

IMPORTANT!

Read and understand the entire user's manual before operating this System. If you have any questions concerning the use of this System, contact your home care provider or doctor.

Contraindications

Studies have shown that the following pre-existing conditions may contraindicate the use of positive airway pressure therapy for some patients:

- Bullous Lung Disease
- Pneumothorax
- Pneumocephalus has been reported in a patient using nasal Continuous Positive Airway Pressure. Caution should be used when prescribing CPAP for susceptible patients such as those with: cerebral spinal fluid (CSF) leaks, abnormalities of the cribriform plate, prior history of head trauma, and/or pneumocephalus.
(Chest 1989; 96:1425-1426)

The use of positive airway pressure therapy may be temporarily contraindicated if you exhibit signs of a sinus or middle ear infection. Contact your physician if you have any questions concerning your therapy.

Specifications

Device Size

Dimensions: 10.0" x 5.55" x 4.25" (25x14x11 cm)
Weight: < 5 lb. (2.27 kg)

Product Use and Storage Environment

Temperature: 41 - 104° Fahrenheit (5 - 40° Celsius)
Humidity: 30-75% Non-condensing
Atmospheric Pressure: 83 - 102 kPascals (storage: 50 - 102 kP)

Power Requirements

The electrical installation of the relevant room must comply with IEC requirements.

115-120 VAC / 230-240 VAC, 50/60 Hz, 0.5 A max.

12 VDC, 2 A DC max.

Class II, Type BF

Degree of protection against harmful ingress of water: ordinary (IPXO)





Mode of Operation: Continuous

Fuses:	Line Voltage	Fuse Type
	115 VAC (115-120 VAC)	T 315 mA, 5 x 20 mm
	230 VAC (230-240 VAC)	T 200 mA, 5 x 20 mm

IMPORTANT!

Use **only** Respironics fuses supplied by your home care provider.

SYMBOL KEY

-  DC Power
-  Type B
-  Fuse
-  Class II (Double Insulated)
-  **Attention, consult accompanying documents**

RESPIRONICS®
1001 Murry Ridge Drive
Murrysville, Pennsylvania
15668-8550 U.S.A.

RESPIRONICS®
Europe
11, Place Royale
44000 Nantes France

0123

WARNINGS & CAUTIONS

WARNING!

Indicates the possibility for injury to the user or the operator.

- This device is intended for adult use only.
- This device is not intended for life support.
- All CPAP devices have the potential to induce rebreathing of exhaled air. To reduce this potential, observe the following:
 - Use only Respironics circuit accessories
 - Do not wear the mask and headgear for more than a few minutes while the unit is not operating
 - Do not block or try to seal the vent holes in the exhalation port

As with most CPAP devices: At low CPAP pressures, the air flow through the exhalation port may not be enough to clear all of the exhaled gas (CO₂) from the mask. You may breathe in some of the air that you have exhaled.

- Under certain conditions, the temperature of the air flow from this device can be as much as 18° F (10° C) higher than the air temperature in the room. Caution should be exercised if the room temperature is warmer than 90° F (32° C).
- This equipment is not suitable for use in the presence of a flammable anesthetic mixture with air or with oxygen or nitrous oxide.
- To avoid electrical shock, disconnect the electrical supply before changing the fuses. For continued protection against risk of fire, replace fuses with those of the exact same type and rating only.
- The instructions in this manual are not intended to supersede established medical protocols.
- Contact your doctor if symptoms of sleep apnea recur.

CAUTION!

Indicates the possibility of damage to the device.

- U.S. federal law restricts this device to sale by or on the order of a physician.
- The voltage must be set for proper line voltage (e.g., North America - 115 V, Europe - 230 V).
- Should the noise level of the Solo change to include unusual or harsh sounds during operation, discontinue use and contact your home care provider.
- Discontinue using the Solo if any of the parts are damaged. Replace any damaged parts before continuing use.
- Tobacco smoke may cause tar build-up within the Solo that may result in the Solo malfunctioning.
- The Solo is powered when the cord is connected to the main supply. The Pressure On/Off button enables/disables the blower only.
- The Solo must be positioned on its base for proper operation.

Additional warnings and cautions are located throughout this manual as they apply.

UNPACKING THE SYSTEM

After unpacking the System, check to make sure you have everything shown here:

Note: Solo *Plus* devices are equipped with a time meter. Solo devices are not.

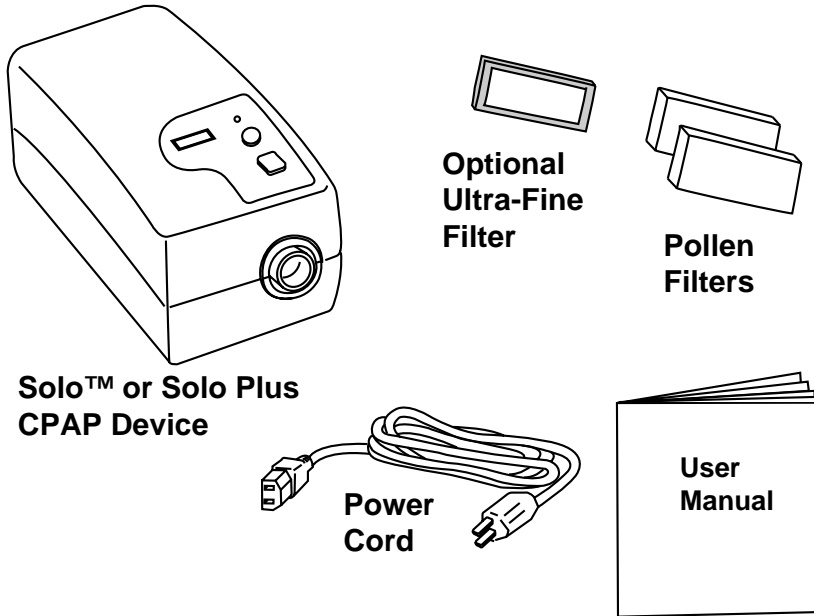

IMPORTANT!

If any of the above parts are missing, contact your home care provider.

Some Solo Systems may also include one or more of the following accessories:

- Headgear
- 6 ft. (1.83 m) Flexible Tubing
- Exhalation Port
- Nasal Mask
- Humidifier
- Carrying Case

SYSTEM FEATURES

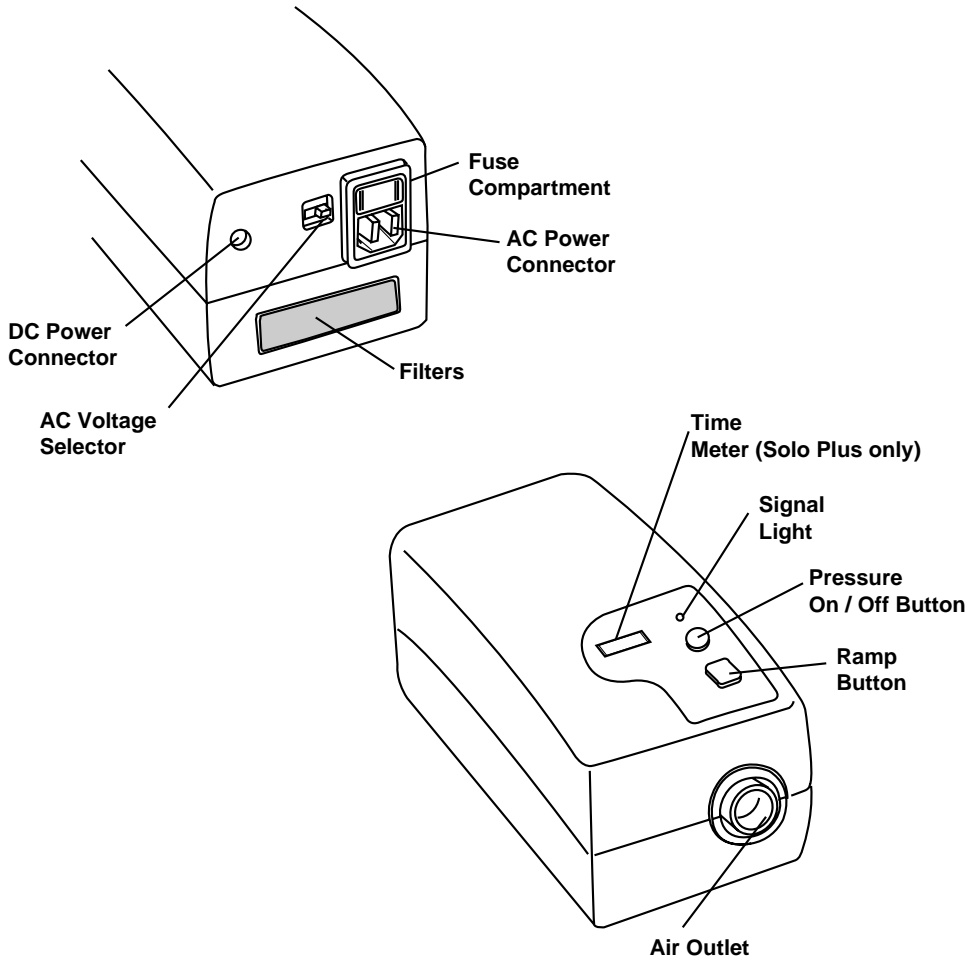

SYSTEM FEATURES

- AC Power Connector** Connect the AC power cord here.
- AC Voltage Selector** This switch is used to select the AC voltage (115V or 230V)
- Air Outlet** Connect flexible tubing here.
- DC Power Connector** Connect the optional DC power cord here.
- Filters** The *pollen filter* screens out normal household dust and pollens. This must be in place at all times when the Solo is operating. An optional, *ultra-fine filter* is also included for more complete filtration of very fine particles.
- Fuse Compartment** This holds the AC fuses. Fuses must be changed if you change the voltage setting for travel (115 V / 230 V).
- Pressure On / Off**
- Button** This button turns the air flow on or off.
- Power Cord** Type H05VV-F.
- Ramp Button** This button decreases the pressure to the minimum pressure setting. When pressed, the pressure delivered will drop to 4 cm H₂O and then gradually increase to the prescribed pressure over a 20-minute time period.
- Signal Light** The green light signals when the Solo is powered.
- Time Meter** (Solo Plus only) Displays the total operation time, including up to 200 hours of factory testing time. Provides resolution to 1/10 hour. Operates only when the airflow is turned on.
- Medical Product Note:** For ease at airport security stations, there is a note on the bottom of the Solo stating that it is medical equipment. It may help if you also take this manual with you when you travel.

FIRST TIME SETUP

WARNING!

Do not use the Solo CPAP System until an appropriate professional adjusts the settings!

To use the system, you will need the following accessories in order to assemble the circuit. Contact your home care provider to order these accessories. These items are not packaged with the System because of the multiple sizes and types available.

- Flexible Tubing -Respironics 6 ft. (1.83 m) flexible tubing with a smooth inner lumen and a 22 mm inner diameter
- Exhalation Port (e.g., Whisper Swivel® or equivalent)

Note: This is not required if you are using a mask with a built-in exhalation port.

- Headgear
- Nasal Mask or other equivalent interface

To determine which circuit accessories are best for you, consult with your doctor or home care provider.

CAUTION!

If the Solo has been exposed to either very hot or very cold temperatures, allow it to adjust to room temperature (approximately 2 hours) before beginning setup.

CAUTION!

When operating the Solo System, make sure bedclothes, curtains, or other items are not blocking the filter cap openings or the vents on the Solo. Make sure the Solo is away from heating equipment (e.g., forced air vents, radiators).

IMPORTANT!

Large elevation changes will affect the pressure being delivered by the Solo. Refer to the “Traveling with the System” section if you relocate or travel to areas with a significantly higher or lower elevation.

FIRST TIME SETUP

Checking the Voltage

1. Verify the voltage selection. Make sure the voltage selector switch on the back of the unit is set correctly (e.g., United States and Canada: 115V).

Note: If you change the voltage setting for travel, the fuses must also be changed.

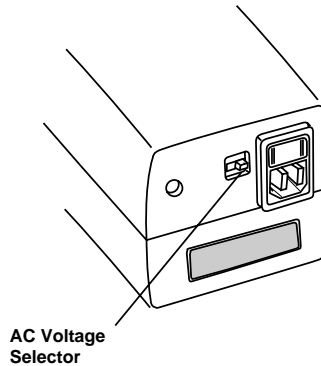

Installing the Filters

2. **Install the filters in the back of the Solo.** The white ultra-fine filter, included with the System, is optional and can be used in addition to the pollen filter. The ultra-fine filter is recommended for people who are sensitive to tobacco smoke or other small particles.

Place one of the pollen filters over the ultra-fine filter. Or, if you are not using the ultra-fine filter, simply place the pollen filter into the filter area on the back of the Solo. An extra pollen filter is included for your convenience. **The pollen filter *must* be in place at all times when the Solo is operating.**

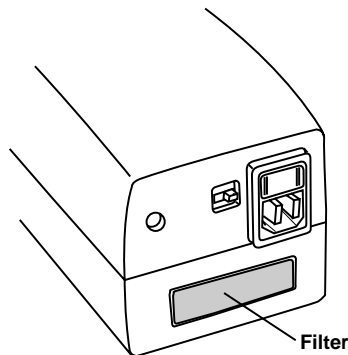

FIRST TIME SETUP

Assembling the Circuit

4. Assemble the circuit.
 - a. Connect the tubing to the air outlet on the front of the Solo.

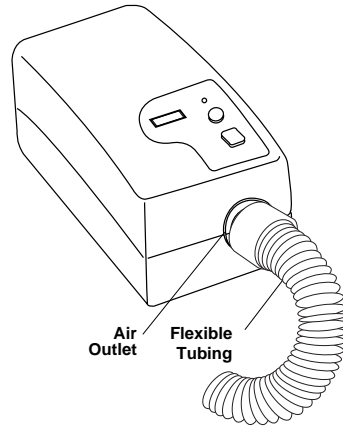

WARNING!

In situations where risk of contamination between the user and the device is high (e.g., sleep lab devices, rental devices, users with respiratory infections), a low-resistance, main flow King™ bacteria filter should be placed in-line between the Solo and the circuit.

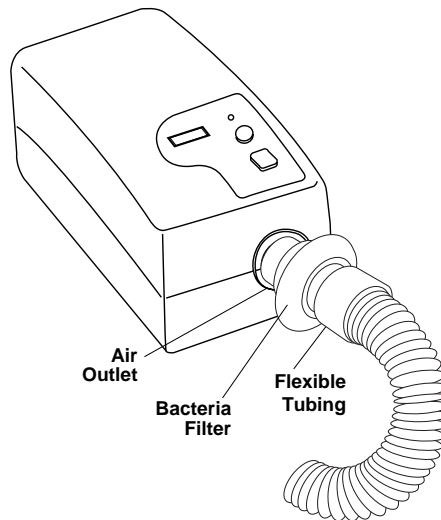

Assembling the Circuit

- b. If you are using a mask with a built-in exhalation port (e.g., Respiration Monarch[®] Mini Mask), connect the mask's connector to the flexible tubing.

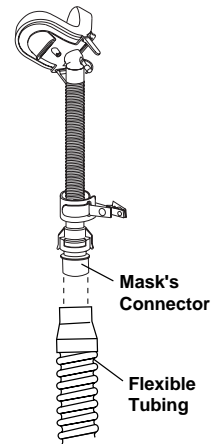

If you are using a mask with a separate exhalation port:

- Connect the exhalation port to the end of the flexible tubing.
- Position the exhalation port so that the vented air is blowing away from your face.
- Connect the mask's connector to the exhalation port.

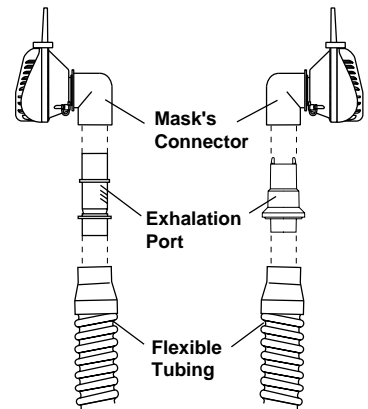

Note: The graphic to the right shows two different types of Whisper Swivel exhalation ports. Both ports are interchangeable, but the one shown on the right is a newer model. Respiration will no longer manufacture the port shown on the left.

WARNING!

The exhalation port is designed to exhaust CO₂ from the circuit. Continuous flow is required for safe operation. Do not block or otherwise try to seal the air openings on the exhalation port.

WARNING!

If you are using a full face mask (i.e., a mask covering both your mouth and your nose), the mask *must* be equipped with a safety (entrainment) valve.

ACCESSORIES

Humidifier

Humidifiers (e.g., Respiroics Oasis™, Pass-over, or Heated) are available from your home care provider. The humidifiers may reduce nasal dryness and irritation by adding moisture to the air flow. Contact your home care provider for additional information.

CAUTION!

When using a humidifier, *always* disconnect the humidifier tubing from the Solo System when it is turned off. Moisture can build up in the System and cause damage to the Solo.

If you are using a *room* humidifier, make sure that it is placed a minimum of 6 feet (1.83 m) away from the Solo.

DC Power System

You can also use the Solo in a recreational vehicle, boat or motor home with a 12 volt DC power source. Contact your home care provider for additional information.

WARNING!

The Solo CPAP System is not intended for use in a mobile environment.

CAUTION!

Do not connect the DC Power System while the Solo is operating on AC power.

Only use the Respiroics DC Power System available from your home care provider. Use of a different system may cause damage to the Solo or your vehicle.

Carrying Case

The carrying case holds the Solo and accessories. When traveling by airplane, the carrying case is for carry-on luggage only. Never check the Solo through the baggage department.

Adding Oxygen to the System

Please note the warnings listed below when using oxygen with the Solo System.

WARNING!

When using oxygen with the Solo System, turn the Solo *on* before turning the oxygen *on*. Turn the oxygen *off* before turning the Solo *off*. This will prevent oxygen accumulation in the Solo.

Oxygen accelerates fire. Keep the Solo and the oxygen container away from heat, open flames, or other sources of ignition. Do not smoke in the area near the Solo or the oxygen.

ROUTINE USE

Connecting the Circuit

1. Connect the circuit. Before each use, examine the flexible tubing for any damage or debris. If necessary, clean the tubing to remove the debris. Replace any damaged tubing.
 - a. Connect the mask to the headgear, following the instructions included with the headgear. Press the Pressure On/Off button on the top of the Solo to turn the air flow ON.

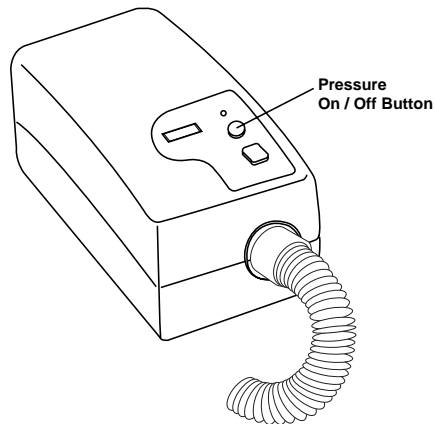

- b. Put on the mask and headgear, and breathe normally through your nose.

Adjusting the Circuit

2. Adjust the circuit.
 - a. Lie down on your bed and adjust the flexible tubing so it is free to move if you turn in your sleep.
 - b. Adjust the mask and headgear until you have a comfortable fit and there are no air flow leaks into your eyes.

When the air flow is on, the green signal light will go out.

NOTE!

Your home care provider or physician may have decided that ramp is not appropriate for your therapy. If the ramp function does not work on your system, contact your home care provider to find out whether or not ramp was prescribed for you.

Using the Ramp Button

Pressing the Ramp button will reduce the air pressure when you are trying to fall asleep. The air pressure will gradually increase until your prescription pressure is reached. You also have the option of not using the ramp feature at all.

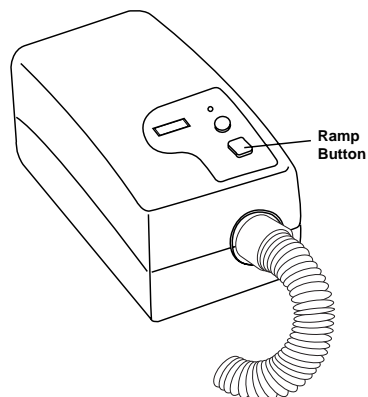

3. Press the Ramp button on the top of the Solo. You can use the Ramp button as often as you wish during the night.

CAUTION!

When using a humidifier, *always* disconnect the humidifier tubing from the Solo System when the air flow is turned off. Moisture can build up in the System and cause damage to it.

Turning the System OFF

4. Press the Pressure On/Off button on the top of the Solo to turn the air flow OFF.

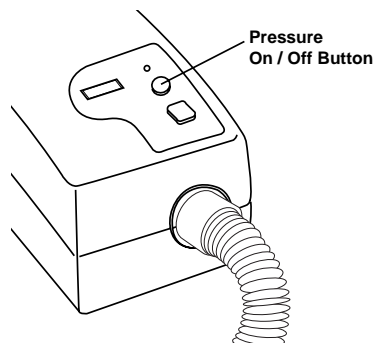

Helpful Hints

- If you want to talk after putting on the mask, use the Ramp button to reduce the pressure. This will make talking easier.
- Make sure that bedding, curtains, or other items are not blocking the filter or vents of the Solo. Air must flow freely around the Solo for the System to work properly.

TRAVELING WITH THE SYSTEM

Packing the System

When traveling, the optional carrying case is for carry-on luggage *only*. The carrying case will not protect the System if it is put through checked baggage.

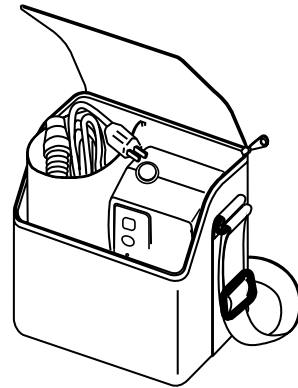

Security Stations

For ease at security stations, there is a note on the bottom of the Solo stating that it is medical equipment. It may be helpful to bring this manual along with you to help security personnel understand the Solo.

Checking the Power Cord

If you are traveling to a country with a line voltage different than the one you are currently using, an international plug adapter may be required to make your power cord compatible with the power outlets of the country to which you are traveling.

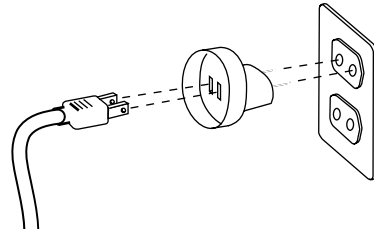

Changing the Voltage and Fuses

If you need a plug adapter, you will probably need to change the voltage setting (115 V or 230 V) and the fuses. Change the voltage setting and install the appropriate fuses into the Solo before traveling. Contact your home care provider to order fuses. (See the instructions for changing the fuses in the “Routine Maintenance” section.)

Contact Respironics International Customer Service department at 1-800-345-6443 (in the U.S. and Canada) or 1-412-731-2100 for more information.

Line Voltage:

115 VAC (115-120 VAC)

230 VAC (230-240 VAC)

Fuse Type:

T 315 mA, 5 x 20 mm

T 200 mA, 5 x 20 mm

CAUTION!

Do not use a voltage converter. It may cause damage to the Solo.

TRAVELING WITH THE SYSTEM

Changes in Elevation

Elevation changes can affect the pressure being delivered by the Solo. At elevations *less than 2,500 ft. (762 m)*, the Solo should be set to the *low* setting. In areas with elevations of *2,500 ft. (762 m) or higher*, the Solo should be set to the *high* setting.

To verify the elevation setting:

1. Make sure the Solo is plugged in and the air flow is turned OFF.
2. Press the ramp button once and release it. The green signal light will flash either one time for the low elevation setting (<2,500 ft.) or three times for the high elevation setting (≥2,500 ft.).

To change the elevation setting:

1. Make sure the Solo is plugged in and the air flow is turned OFF.
2. Press the ramp button and hold it down. While holding the ramp button down, press and release the pressure on/off button. Release the ramp button.
3. Verify the elevation setting. Press the ramp button once and release it. The green signal light will flash to verify the elevation setting.
one flash - low elevation setting (<2,500 ft.)
three flashes - high elevation setting (≥2,500 ft.)

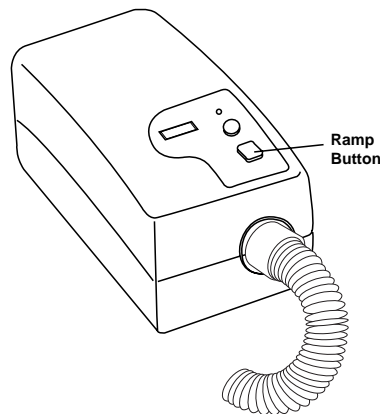

ROUTINE MAINTENANCE

Cleaning and Replacing the Filters

The gray pollen filter is a reusable filter that screens out pollens and some household dust. This filter should be cleaned at least once every two weeks under normal usage and replaced with a new one every six months. One additional pollen filter is included with the System. **The pollen filter *must* be in place at all times when the Solo is operating.**

The white ultra-fine filter increases filtration of pollens, dust, some tobacco smoke, and other small particles. The ultra-fine filter is included with the System, but is optional, and should be used in *addition* to the pollen filter. **The ultra-fine filter should never be used without the pollen filter.** Replace the ultra-fine filter after 30 nights of use or sooner if it appears dirty. **Do not** clean the ultra-fine filter.

CAUTION!

Failure to replace or clean a dirty filter may cause the Solo to operate at higher temperatures and damage the Solo.

To change the filters:

1. Remove the pollen filter by gently pulling around the edges of the filter. Rinse the filter in a steady stream of running water. Squeeze out the water and repeat. Air dry on a rack for 8 to 12 hours or in a clothes dryer for 15 to 20 minutes.
2. If you are using the white ultra-fine filter, remove the ultra-fine filter if it appears dirty and discard. Replace with a new filter.
3. Place the pollen filter over the ultra-fine filter. Insert the filters into the filter area in the back of the Solo.

The filter must be completely dry before use. Never place a wet filter into the Solo. We recommend that you clean the filter in the morning and alternate using the two pollen filters provided with the System to ensure enough drying time for the cleaned filter.

ROUTINE MAINTENANCE

Changing the Fuses

If the Solo does not turn ON when the power cord is plugged in, the fuses may need to be replaced. If you change the voltage setting, the fuses *must* be changed. The fuses are located in the back of the Solo above the power cord connector.

WARNING!

Unplug the Solo before changing the fuses. Use only Respironics fuses supplied by your home care provider.

1. Remove the fuse holder by releasing the small tabs on the sides of the holder. You may need a small screwdriver to help remove the holder.
2. Replace the old fuses with new fuses of the same type and rating. Use only Respironics fuses supplied by your home care provider. Always replace *both* fuses.

Line Voltage:

115 VAC (115-120 VAC)

230 VAC (230-240 VAC)

Fuse Type:

T 315 mA, 5 x 20 mm

T 200 mA, 5 x 20 mm

3. Insert the fuse holder back into the Solo and snap into place.

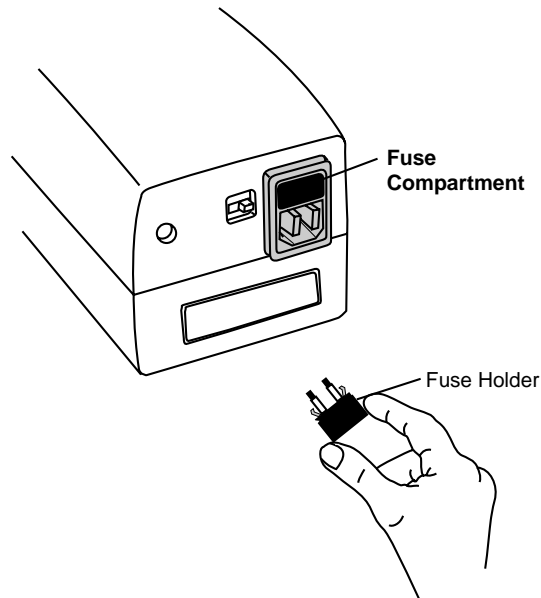

ROUTINE MAINTENANCE

Cleaning the System

WARNING!

**To avoid electrical shock, unplug the Solo before cleaning.
Do not immerse the Solo into any fluids.**

1. Disconnect the flexible tubing from the Solo.
2. Wipe the outside of the Solo with a cloth slightly dampened with water and a mild detergent. Let the Solo dry before plugging in the power cord.
3. Inspect the Solo and all circuit parts for any damage after cleaning. Replace any damaged parts.

Reordering

Contact your home care provider to order accessories or replacement filters and fuses.

ROUTINE MAINTENANCE

Service

The Solo System does not require routine servicing.

- If symptoms of sleep apnea recur, contact your physician.
- If you think the Solo is not performing properly or is not delivering the correct air pressure, contact your home care provider.
- If the noise level of the Solo has changed to include unusual or harsh sounds during operation, contact your home care provider or Respironics for instructions on having the Solo serviced.

WARNING!

If the Solo malfunctions, contact your home care provider immediately. Never attempt to open the Solo's enclosure.

MAINTENANCE RECORD

Filter(s) Replaced

Mask Replaced

Pressures Checked

Hours on Time Meter

(Solo Plus only)

TROUBLESHOOTING

The table below lists common problems you may have with the Solo System and possible solutions to those problems. If none of the corrective actions solve the problem, contact your home care provider.

Problem	Solutions
Sore or dry eyes	Readjust the headgear. Contact your home care provider to be fitted for a different mask style or size.
Redness on your face where the mask contacts your skin	Loosen the headgear. Check the mask's spacer to see that it is in good condition. Use a barrier between your skin and the mask, such as 3M's Microfoam™ tape, Squibb's Duoderm™ or Hollister's Restore™. If you are using Respirationics' Contour Nasal Mask, try adding a Comfort Flap® mask accessory. Contact your home care provider to be fitted for a different mask style or size. Contact your doctor if the problem persists.
Dryness or burning sensation in your throat or nose	Consult with your doctor or home care provider about using a humidifier with the Solo. If you are using a nasal mask, you may want to also use a chin strap to help keep your mouth closed during the night.
Nasal, sinus, or ear pain	You may have a sinus infection or middle ear infection. Stop using the Solo and contact your doctor.
The pressure being delivered feels different	Check the elevation setting to be sure it is set to your elevation. Change the elevation setting if necessary. If the elevation setting is correct, contact your home care provider or Respirationics, Inc. for directions on having the Solo serviced. Please have the Solo's serial number ready when you call.

TROUBLESHOOTING

Problem

Solutions

The air flow from the Solo seems warm.

Replace or clean the filter. Make sure the Solo is away from bedding or curtains that could block the flow of air around the Solo. Make sure the Solo is away from heating equipment (e.g., forced air vents, radiators).

The Solo is making a faint humming sound when the air flow is turned off.

This is a normal characteristic of the Solo. If the humming sound is significantly louder than it usually is, contact your home care provider or Respironics, Inc. for directions on having the Solo serviced. Please have the Solo's serial number ready when you call.

The noise level of the Solo has changed to include unusual or harsh sounds during operation.

Contact your home care provider or Respironics, Inc. for directions on having the Solo serviced. Please have the Solo's serial number ready when you call.

The Solo will not turn on.

Make sure that the Solo is plugged into a working outlet. Replace the Solo's fuses if the green signal light does not come on. Verify that the correct voltage has been selected (i.e., if your electrical line is 115 V you must use the 115 V voltage setting). Press the Pressure On/Off button. If the new fuses blow out, contact your home care provider. If you are using a DC battery, the battery may need to be recharged or replaced.

The Solo Plus has hours recorded on the time meter when it is delivered.

The Solo Plus is tested at the factory prior to shipment. It is normal for up to 200 hours of testing time to be recorded on the Solo Plus.

LIMITED WARRANTY

Respironics, Inc.[®] warrants that the Solo™ CPAP device shall be free from defects of workmanship and materials and will perform in accordance with the product specifications for a period of two (2) years from the date of sale by Respironics, Inc. to the dealer. If the product fails to perform in accordance with the product specifications, Respironics, Inc. will repair or replace, at its option, the defective material or part. Respironics, Inc. will pay customary freight charges from Respironics, Inc. to the dealer location only. This warranty does not cover damage caused by accident, misuse, abuse, alteration and other defects not related to material or workmanship.

RESPIRONICS, INC. DISCLAIMS ALL LIABILITY FOR ECONOMIC LOSS, LOSS OF PROFITS, OVERHEAD OR CONSEQUENTIAL DAMAGES WHICH MAY BE CLAIMED TO ARISE FROM ANY SALE OR USE OF THIS PRODUCT. SOME STATES DO NOT ALLOW THE EXCLUSION OR LIMITATION OF INCIDENTAL OR CONSEQUENTIAL DAMAGES, SO THE ABOVE LIMITATION OR EXCLUSION MAY NOT APPLY TO YOU.

THIS WARRANTY IS GIVEN IN LIEU OF ALL OTHER EXPRESS WARRANTIES. IN ADDITION, ANY IMPLIED WARRANTIES, INCLUDING ANY WARRANTY OF MERCHANTABILITY OR FITNESS FOR THE PARTICULAR PURPOSE ARE LIMITED TO TWO YEARS. SOME STATES DO NOT ALLOW LIMITATIONS ON HOW LONG AN IMPLIED WARRANTY LASTS, SO THE ABOVE LIMITATION MAY NOT APPLY TO YOU. THIS WARRANTY GIVES YOU SPECIFIC LEGAL RIGHTS, AND YOU MAY ALSO HAVE OTHER RIGHTS WHICH VARY FROM STATE TO STATE.

To exercise your rights under this warranty, contact your local, authorized Respironics, Inc. dealer or Respironics, Inc. at 1001 Murry Ridge Drive, Murrysville, Pennsylvania 15668, 1-800-345-6443 or 1-412-731-2100.

This summary is not intended to replace the complete user instructions. The entire manual should be read and understood before operating the Solo System.

Step 1 Check that the correct voltage setting has been selected (e.g., N. America - 115 V, Europe - 230 V). Change the voltage setting and fuses, if necessary.

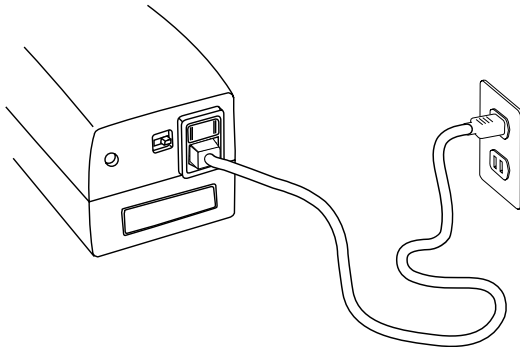
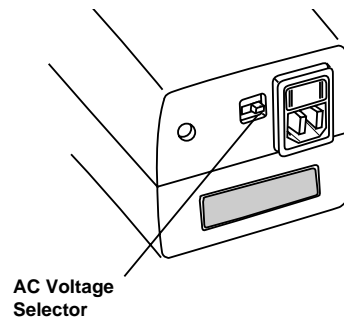

Step 2 Plug the power cord into the AC power cord connector and an electrical outlet.

Step 3 Press the ramp button to verify that the correct elevation setting has been selected (i.e. one flash = low elevation; three flashes = high elevation).

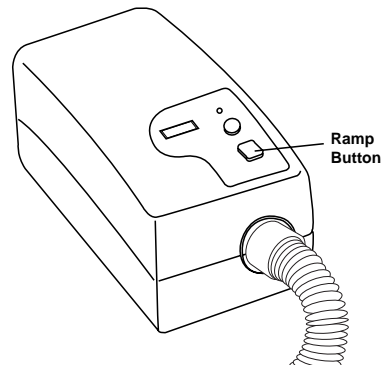

SUMMARY

Step 4 Connect the flexible tubing, exhalation port, and mask. Adjust the mask and headgear.

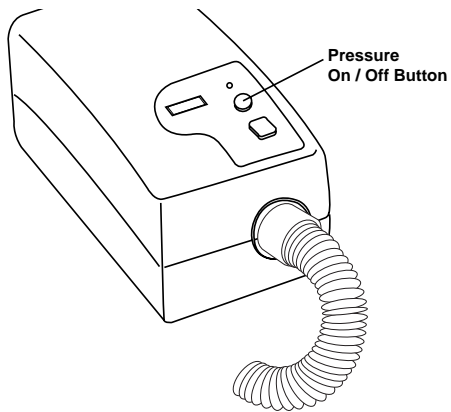
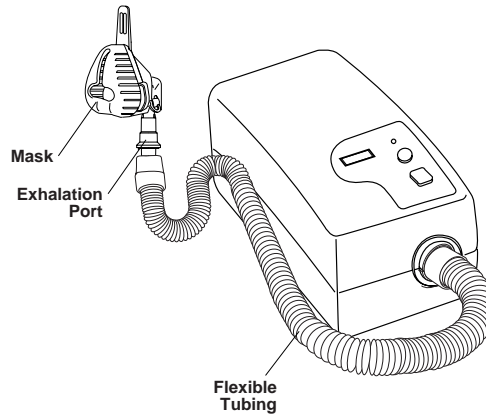

Step 5 Turn the air flow on or off by pressing the Pressure On/Off button.

Step 6 (Optional) Press the Ramp button to reduce the pressure.

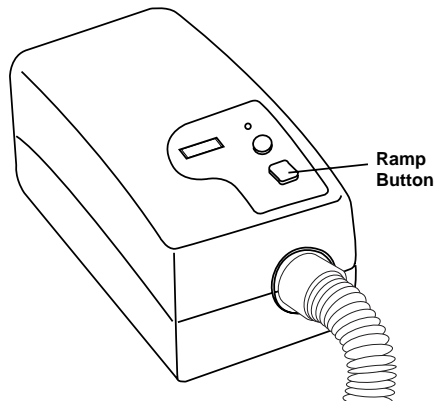

IMPORTANT!

Fill in the information below when you receive the Solo™ or Solo™ Plus CPAP System.

Solo Serial No.: _____ (Located on the bottom of the Solo)

System Prescribed for: _____

Date of Purchase or Rental: _____

Pressure Setting: _____ cm H₂O

Mask Type: _____

Mask Size: _____

Comfort Flap® Nasal Mask Accessory: yes no

If you have any questions concerning the System, contact:

• Home Care Company: _____

 Telephone Number: _____

• Doctor: _____

 Telephone Number: _____

• Respironics, Inc.

 1001 Murry Ridge Drive

 Murrysville, Pennsylvania

 15668-8550 U.S.A.

 Customer Service

 Telephone Number: 1-800-345-6443 or 1-412-731-2100

SOLO™ TWO-YEAR WARRANTY

Please fill out this warranty/comment card and return it in the attached envelope.

Upon receipt of this card, your two (2) year warranty will become active. This information will be kept confidential by Respironics, Inc. **Your comments are important to us, and in appreciation for returning this card, a FREE package of six ultra-fine and two pollen filters (p/n 622019) will be mailed to you.**

WARRANTY INFORMATION:

Your Name _____ Serial # _____ Model # _____

Address _____ Date of Purchase _____

City _____ State _____ Home Care Company _____

Zip _____ Phone No. () _____ City / State _____

OPTIONAL: Male Female Age: Under 20 20-29 30-39 40-49 50 and over

Comments: _____

See other side for extended warranty information.

• OPTIONAL EXTENDED WARRANTY •

Extend your warranty to THREE years at a cost of only \$39.95. Complete all of the information on both sides of this card, and return this card in the attached envelope within 90 days of purchase, or call Respironics Warranty Administrator at 1-800-666-2901. As a bonus, when you purchase the extended warranty, we will send you an additional FREE package of ultra-fine filters.

YES, I want to extend my warranty period from two years to three years.

METHOD OF PAYMENT

Check or Money Order Enclosed

Please make check or money order payable to Respironics, Inc.
Mail this card and payment of U.S. \$39.95 to Respironics, Inc. in the attached, self-addressed envelope.

Charge \$39.95 to my **Visa or** **MasterCard Account**

Card Number _____

Signature _____ Exp. Date _____

POSTAGE
REQUIRED

RESPIRONICS INC.®
P.O. BOX #640292
PITTSBURGH PA 15264-0292

FIRST TIME SETUP

Power Cord

3. Connect the power cord.

Plug the socket end of the power cord into the AC power cord connector on the back of the Solo and the pronged end of the power cord into an electrical outlet.

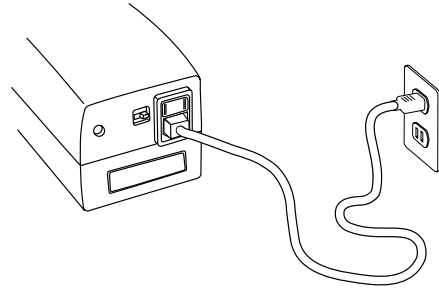

IMPORTANT!

When the power cord is connected, the green signal light will blink several times.

IMPORTANT!

An international plug adapter may also be required to make your power cord compatible with the electrical outlet of the country you are in. If further assistance is required, contact Respironics International Customer Service department at 1-800-345-6443 or 1-412-731-2100.

CAUTION!

Do not use a voltage converter. It may cause damage to the Solo. Inspect the power cord often for any signs of damage. Replace a damaged cord immediately.



RESPIRONICS INC.®

1001 Murry Ridge Drive
Murrysville, Pennsylvania
15668-8550 USA

626023
JBM 9/30/97